



PRICE LIST 2007 / 2008
OCTOBER 1, 2007

F.O.B. ORIGIN • SENATOBIA, MS - USA • PREPAID FREIGHT
DEALER SERVICE 1-866-777-1951 • FAX 1-800-336-1651
www.chromcraftcontract.com

POSSESSION OF THIS CATALOG OR PRICE LIST DOES NOT IMPLY THE RIGHT TO PURCHASE PRODUCTS SHOWN HEREIN. SALES ARE RESTRICTED TO ACCOUNTS ESTABLISHED AS AUTHORIZED DEALERS ONLY.

GENERAL INFORMATION

TERMS: Net 30 Days from date of invoice.

PRICES: F.O.B. Origin, Senatobia, Mississippi. Prices are subject to change without notice. All orders are invoiced at prices prevailing at time of acknowledgement. Chromcraft reserves the right to make modifications and design changes without notice.

PRICING, SHIPPING, and DELIVERY: All deliveries shall be F.O.B. origin, prepaid freight to your designated facility within the continental United States on all orders that exceed \$700 list price. On orders for less than \$700 at list price, there is a minimum freight charge of \$50 or actual UPS charges. Under the terms – F.O.B. origin – at the point of shipment, title to the goods and responsibility of same, passes to your company. In the event of damages, contact the delivering carrier for an inspection and file claim. We will attempt to assist you in every way possible. However, we cannot file claim with the carrier on your behalf. Chromcraft has the right to determine the carrier, method of shipment, and routing. Extra expense resulting from customer request for special carrier, method of shipment, and/or routing will be billed to the customer at our cost. **CALL BEFORE DELIVERY** charge of \$25 per order.

SPECIAL FIRE CODE: Some Chromcraft patterns meet Boston Fire Code and New York Port Authority (see swatch cards for specs). All other orders to meet this requirement must be handled as **CUSTOMER OWN MATERIAL (COM)**. A 15% of grade two upcharge will be added to each item to cover special foam to meet these requirements. This upcharge also applies to items that must meet California 133 Code.

ORDER CHANGES: All requests to change or cancel an order are subject to our ability to confirm. Changes and cancellations are possible only prior to the order being put into production. **AFTER AN ORDER IS PLACED IN PRODUCTION, CANCELLATION OR CHANGE CANNOT BE ACCEPTED AND THE ORDER MUST BE SHIPPED UPON COMPLETION.** Orders for special items are not returnable.

CLAIMS AND ALLOWANCES: WE CANNOT BE RESPONSIBLE FOR ANY FACTORY DEFECTS NOT REPORTED TO THE FACTORY PROMPTLY AFTER MERCHANDISE IS RECEIVED. We reserve the right to specify that items or parts claimed to be defective, be returned to the factory for our inspection. If the claim is justified, the item(s) will be repaired or replaced at no charge.

SERVICE CALLS and all related expenses are the sole responsibility of the furniture dealer.

RETURNS: NO MERCHANDISE MAY BE RETURNED FOR CREDIT OR REPAIR WITHOUT OUR WRITTEN APPROVAL. MINIMUM \$25 RESTOCKING FEE WILL APPLY IF APPROVED

TRANSIT LOSS OR DAMAGES: All shipments are delivered to the transportation company in good condition. Our responsibility ceases at that time. Each carton should be carefully examined at the time of delivery to determine if there is any evidence of transit damage. All cartons should be opened and the contents examined in order to check for concealed transit damage. In the event of damages, contact the delivering carrier for an inspection and file claim. We will attempt to assist you in every way possible. However, we cannot file claim with the carrier on your behalf.

PRODUCT NUMBER EXPLANATION

EXAMPLES:

Chair

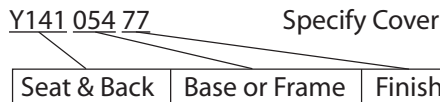

Table

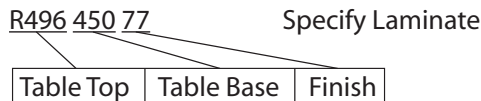

CHROMCRAFT CONTRACT FURNITURE

P. O. Box 126 • Senatobia, Mississippi 38668 • 662/562-8203

www.chromcraftcontract.com

Dealer Services 1-866-777-1951

How to order:

FAX 1-800-336-1651 • orders@chromcraftcorp.com

INDEX BY PRODUCT NAME

General Information	2-11
Grade-In Fabrics	6-9
Chair Mechanisms	10-11
Seating, Chairs -- Ergonomic	
Edge	22-23
Genesis	18-21
Me	12-13
Trak	14-15
Ultima II	16-17
Seating, Chairs -- Metal	
Arc	38- 39
Ascend	62- 63
Ascend Plus	64- 65
Diva	40- 43
Epix	30- 31
Facet	74- 75
Facet Molded Back	76- 77
Icon	32- 33
Icon Ultra	34- 35
Iso	54- 59
Iso ST	60- 61
Pliant	68- 73
Pliant ST	72- 73
Pyramid	48- 51
Pyramid Wall-Saver	52- 53
Quest	36- 37
Solas	38- 39
Stools	78- 79
Syntax & Syntax Plus	46- 47
Tria	36- 37
Vista	44- 45
Zyn	24- 29
Seating, Chairs -- Wood	
Breton	82-83
Icon Wood	80-81
Quest Wood	80-81
Secura	84-85
Solas Wood	84-85
Traditional	86-87
Multiple Seating	
Guardsman	92-93
Guardsman II	94-95
Revolution	88-91
Lounge Seating	
Secura Lounge	98-99
Traditional	96-97
Tables	
Occas. Table(Ascend)	66-67
Occas. Tables (Pyramid)	48-49
Conference Tables	100-107
Tassk Tables	108-121
Electrical wiring	123
Lecterns	121

NUMERICAL PRODUCT INDEX

<u>Item Number</u>	<u>Name</u>	<u>Page</u>
A902-A912	Pyramid Benches	50-51
AL01-AL05	Lecterns	121
L 64-L 66	Revolution	88-91
L 74-L 75	Guardsman	92-93
L174-L175	Guardsman II	94-95
L562-L563	Traditional Lounge	96-97
L571-L583	Secura Lounge	98-99
R200-R399	Tassk Tables	108-121
R400-R799	Conference Tables	100-107
R942-R944	Occas. Table (Pyramid)	48-49
R961-R963	Occas. Table(Ascend)	66-67
X002-X023	Pliant ST	72-73
X078	Traditional Lounge	96-97
X131-X148	Breton	82-83
X171-X259	Traditional	86-87
X241-X247	Epix	30-31
X280-X287	Trak	14-15
X321-X329	Icon	32-33
X331-X339	Icon Ultra	34-35
X351-X357	Icon Wood	80-81
X381-X387	Solas	38-39
X391-X397	Solas Wood	84-85
X444	Secura	84-85
X461-X467	Quest	36-37
X481-X488	Tria	36-37
X631-X644	Secura	84-85
X731-X737	Arc	38-39
X871-X877	Quest Wood	80-81
X902-X905	Vista	44-45
X917-X920	Syntax	46-47
X939-X950	Pyramid	48-51
X939-X950	Pyramid Wall-Saver	52-53
X959-X968	Iso	54-59
X969-X976	Ascend	62-63
X980-X984	Diva	40-43
X989-X997	Pliant	68-71
Y100-Y145	Genesis	18-21
Y159-Y166	Iso ST	60-61
Y203-Y235	Edge	22-23
Y300-Y367	Zyn	24-29
Y401-Y434	Ultima II	16-17
Y501-Y553	Me	12-13
Y919-YU20	Syntax Plus	46-47
Y930-Y938	Facet	74-75
Y940-Y948	Facet Molded Back	76-77
Y950 - Y951	Facet Special Purpose	74-75
Y969-Y976	Ascend Plus	64-65
Z103-Z941	Stools	78-79

CHROMCRAFT WARRANTY 2007-2008

Chromcraft Furniture warrants to the original end user that our products will be free from defects in its materials and workmanship as described below. Chromcraft will repair or replace, at its option, any Chromcraft product or component that is defective in workmanship or material as long as you the original purchaser own the product. This warranty is subject to the provisions below. The stated warranty applies to products manufactured and shipped after **October 1, 2007** from our Senatobia, MS facility. *Prior warranty claims will be based on the manufacturers warranty in effect at the time of product purchase.*

The following warranties are your sole remedy for product defects and excludes defects due to or arising from, product abuse, misuse, user modification of or attachments to the product, including application of upholstery materials and products or parts not used, maintained or installed in accordance to the companies installation, maintenance and or guidelines. Your warranty shall be effective for the applicable time period beginning from your date of purchase as shown on your original receipt or proof of purchase.

In the event of a product failure during normal use (standard 8 hour day, 5 days per week) within the applicable warranty period, please send description of the product, part and nature of failure along with proof of purchase to the following address.

Chromcraft Contract
P.O. Box 126
Senatobia, MS 38668

Limitations concerning materials and components: This warranty is subject to the provisions listed below. The components and materials below are covered according to the following schedule from the purchase date.

Twelve years: All metal office seating, metal and wood combination seating, Wood office seating, multiple seating, and training tables; this warranty includes but is not limited to: control mechanisms, bases, casters, glides, Molded Ultrafoam® and pneumatic cylinders for products produced in our Senatobia, MS facility. *24/7 warranty is six years and covers the same components above.*

Ten Years: conference tables and bases are warranted for a period of ten years of normal use against defects in craftsmanship or structural failure.

Five Years: All wood lounge furniture is guaranteed against structural failure for a period of five years of normal use.

Five Years: Q&A products (Balmoral, Luxur, Trak & Icon) are warranted for a period of five years of normal use against defects in craftsmanship or structural failure.

Fabric and Foam

Five Years: Standard Chromcraft upholstery materials listed in our Specification/Price List as Available Fabrics/Price Grades and Grade-In patterns (Maharam and Momentum) are guaranteed for five years against unusual wear provided the material is not abused and has been cared for properly. This warranty is based on single shift 40 hour work week.

Warranty Exclusions:

Neither the above warranty nor any other warranties applies to the following:

- Normal wear and usage which are to be expected over the life of any product.
- Modifications or attachments to the product that are not approved by Chromcraft.
- Products that are not assembled installed or maintained per Chromcraft's product instructions and warnings.
- Damage caused by the carrier in transit, which are covered under separate terms.

In the event of a product failure, the part(s) of the product that is defective will be replaced at no charge with freight prepaid to the dealer or end-user. **ANY OTHER RELATED EXPENSES INCLUDING LABOR FOR INSTALLATION OR ANY LOCAL TRANSPORTATION IS NOT INCLUDED OR COVERED BY THIS WARRANTY.**

This warranty is based on a standard work week, single shift 8 hours per day, 40 hours per week. For 24/7 applications your warranty is six years and covers the same materials as our standard warranty.

This warranty applies only to products sold within the United States of America after October 1, 2007.

ALL CLAIMS MUST HAVE A PRIOR INSPECTION AND FACTORY APPROVAL BEFORE ANY RETURN OR REPLACEMENT CAN BE MADE.

THE WARRANTY ABOVE IS SUBJECT TO CHANGE WITHOUT NOTICE.

UPHOLSTERY AVAILABILITIES/PRICE CATEGORIES:

<p>Grade I</p> <p>Fabrics Basis Insight Origin Sassy</p> <p>Vinyls Allante</p>	<p>Grade II - cont.</p> <p>Fabrics Factor Interval Jinx Milestone Perk Pivot Russo</p> <p>Vinyls Cashmere Regal</p>	<p>Grade III</p> <p>Fabrics Cachet Hue Medium Messenger Mimic Ringo Solo Stance Verge</p> <p>Vinyls Bravo Lariat</p>	<p>Grade IV</p> <p>Fabrics Beckon Boom Consider Gradient Impact Marquee Order Setting Verdant</p>	<p>Grade LM</p> <p>Top Grain Leather/Vinyl Match (Mammut/Cortz)</p>
<p>Grade II</p> <p>Fabrics Era Expo</p>			<p>Grade V</p> <p>Fabrics Arbor</p>	

Guidelines For Fabric

Talking about direction

Fabrics come on roll. The long threads that run parallel to the length of the roll are called the warp. The perpendicular threads that run parallel to the width of the roll are called the filling.



Wrap vertical means the height dimension of the product is parallel to the wrap of the fabric.



Wrap horizontal means the height dimension of the product is perpendicular to the wrap of the fabric.

Regular Cut vs. Railroaded



Regular Cut means the same thing as *wrap vertical, down roll, or up roll*. The selvage is on the left and right side.



Railroaded means the same thing as *wrap horizontal or across roll*. The selvage is on the top and bottom.

Up and Down

Is there a design or pattern that must point one way or can it be turned 180 degrees?

Has up and down:

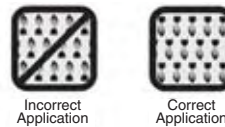

Does NOT have an up and down:

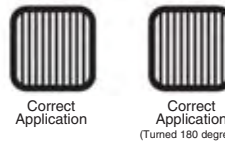

Up and Down - continued

If the pattern has a direction, but you cannot see it in the swatch size being used, it is best to mark this as NOT having an Up and Down Direction.

Face Side

If Chromcraft is to hold a specific face side, and it is not obvious from the backing, please supply face side standards.

Chromcraft will supply above patterns in the colors shown on our swatch cards as part of our Designer Fabric program.

All others MUST be handled as C.O.M.

CUSTOMER'S OWN MATERIAL (C.O.M.) — GRADE II COLUMN: Without approval by Chromcraft C.O.M. orders will not be accepted and acknowledged. Because of difference in material, pattern or applicability, **it is necessary to receive a 12" x 12" sample of fabric** to test on specific item before approval of order (and before sending C.O.M. yardage to us). **SPECIAL NOTE: We assume NO RESPONSIBILITY for the durability or tailoring quality of customer's own material.** Prices are listed under price Grade II. **YARDAGE REQUIREMENTS SHOWN IN THE PRICE LIST ARE BASED ON NON-DIRECTIONAL GOODS OF 54" WIDTH. FABRICS LESS THAN 54" WIDE WILL REQUIRE YOUR COMMUNICATING WITH OUR CUSTOMER SERVICE DEPARTMENT FOR AMOUNT OF ADDITIONAL YARDAGE AND FURTHER INSTRUCTIONS.**

IF FURNISHED FABRIC INCLUDES DESIGN OR STRIPE, PLEASE INDICATE WHETHER FABRIC IS TO BE APPLIED WITH DESIGN OR STRIPE RUNNING HORIZONTALLY OR VERTICALLY. INDICATE WHICH SIDE OF MATERIAL IS TO BE EXPOSED.

WE DO NOT GUARANTEE STRIPES, PRINTS, OR PATTERNS TO MATCH HORIZONTALLY OR VERTICALLY.

To avoid delay in processing your order, please supply the following information on all C.O.M. orders:

A sample of the fabric should be stapled to the order. Indicate which side of the fabric is to be exposed. Specify the supplier's name, fabric number, color and description on each order. Please specify the Chromcraft model number, order number and finish on which the fabric will be used.

NOTE: The fabric supplier must include the following information on all shipping labels:

Dealer Name / Government Office and Purchase Order Number.
Chromcraft Model Number.
Shipping Address:
Chromcraft Contract Furniture
1 Quality Lane
Senatobia, Mississippi 38668

All Shipments Must Be Pre-Paid.

If your order includes both Chromcraft fabric and C.O.M., A SHIPPING DATE CANNOT BE ASSIGNED NOR WILL THE ORDER BE ENTERED OR PUT INTO PRODUCTION UNTIL ALL THE C.O.M. IS RECEIVED AT THE FACTORY.

PATTERNS IN **BOLD** FACE TYPE ARE PART OF CHROMCRAFTS STANDARD FABRICS PROGRAM

MAHARAM 2008											
GRADE-IN											
DESCRIPTION	GRD										
AF24	A	Mix	F	Kernel	B	Flaunt	IV	Racer	IV	Frolic	A
AF43	A	Motive	IV	Panache	C	Flipside	V	Rave	A	Gardener	A
AF79	A	Occasion	V	Pipa	B	Frank	IV	Ready Set Go	A	Hermosa	A
AF96	A	Odalisque	B	Shimmy	B	Gabe	V	Rebound	A	Hub	A
Amble	B	Order	IV	Skate	B	Gemini	IV	Relic	V	Hugs And Kisses	A
Anecdote	A	Orissa	D	Stroll	B	Gig	III	Remy	A	Huntington	A
Arbor	V	Pause by Kvadrat	A	Swerve	B	Gumption	IV	Rendezvous	V	Impulse	A
Aria	E	Peep	F	Symbol	C	Hue	III	Rendition	V	Infusion	A
Around	E	Perception	D	Token	B	Hue+gore	V	Revue	V	Jax	A
Balustrade	D	Perhaps	V	Venn	C	Hype	A	Ringo	III	Jest	A
Beckon	IV	Pictogram	F	Verse	C	Idiom	B	Russo	II	Jolt	V
Before	A	Plexus	B	Wrought	C	Impact	IV	Saucy	IV	Junction	B
Betwixt	V	Quad	A			Incognito	A	Saucy+boss	V	Locale	A
Binary	E	Queue	F	VINYLS:		Inking	V	Savannah	IV	Malibu	C
Blitz by Kvadrat	C	Radiant	F	PATTERN	GRADE	Intermix	III	Sensation	IV	Maxim	A
Boheme	V	Ranger	B	Article	IV	Interval	II	Sense	A	Mulholland	A
Bridge	B	Reveal	D	Candid	V	Ism	IV	Sequel	V	Niche	A
C210	B	Reverie	V	Flicker	V	Jammin	B	Shift	A	Paper Route	A
C220	B	Rivet	C	Lariat	III	Jay	A	Simplex	III	Pomona	C
Calyx	C	Salon	F	Ledger	A	Jensen	A	Snazzy	IV	Proof	A
Canyon by Kvadrat	D	Scout	B	Pose	B	Jinx	II	Snazzy+boss	V	Query	A
Cavort	C	Sequence	D	Sudden	B	Jinx+boss	V	Solano	B	Redondo	A
Chenille Cord	D	Setting	IV	Wafee	B	Jinx+gore	A	Solo	IV	Reminisce	A
Chenille Stitch	E	Single	V			Juicy	IV	Sonic	B	Rio	A
Chenille Stripe	F	Solace	D	MOMENTUM 2008		Leaflet	III	Spangle	B	Schmooze	A
Chime	A	Squarely	A	GRADE-IN		Linea	C	Spellbound	IV	Scoupe	A
Cipher	D	Steelcut Trio	D	PATTERN	GRADE	Linq	F	Spence	V	Segue	A
Consider	IV	Suggestion	D	Acacia	A	Logic	V	Sprocket	B	Sepulveda	A
Dash	B	Survey	A	Accolade	V	Lucia	V	Stance	III	Shag	A
Decode	C	Tai	F	Adage	V	Luxe	V	Streamline	IV	Sheen	A
Defer	A	Teeter	V	Altro	C	Mara	A	Swoon	II	Smart Suede	V
Diagram	C	Tinta by Kvadrat	C	Anais	B	Maverick	A	Synthesis	A	Sway	A
Divina by Kvadrat	E	Tonica by Kvadrat	C	Axiom	A	Media	A	Taction	A	Topanga	A
Divina Melange by Kvadrat	E	Tonus by Kvadrat	D	Azmi	A	Melange	B	Tease	IV	Tribute	V
Division	A	Topas by Kvadrat	D	Bailey	IV	Memoir	V	Tek	V	Tryst	A
Double Check	C	Trait	B	Banderole	V	Merry	IV	Telltale	A	Tweed	A
Elapse	D	Treat	C	Baxter	A	Merry+boss	V	Theory	V	Unhinged	A
Envelop	F	Trinket	IV	Bloomfield	III	Mimic	III	Thesis	V	Velese	A
Episode	F	Tundra by Kvadrat	E	Boom	IV	Mindset	V	Tranceport	B	Viva	A
Even	F	Undulating Stripe	C	Bree	V	Mod	B	Transit	IV	Wishes	A
Fathom	D	Upright	C	Burst	A	Montage	A	Velluto	IV	Zoom	A
Figment	D	Venue	D	Cachet	III	Morphe	A	Verbatim	IV		
Flora by Kvadrat	C	Verdant	IV	Camelot	V	Motto	V	Verge	III	VINYLS	
Fluctuate	B	Vignette	A	Chat	III	Multiplicity	III	Vibe	IV	PATTERN	GRADE
Fortis	C	Waterfront	A	Chat+boss	V	Network	II	Vita	A	Agora	III
Gradient	IV	Wavering Stripe	C	Cheers	IV	Nexus	III	Whirlwind	B	Athens	IV
Groove	E	Weimar	F	Cheers+boss	V	Nostalgia	V	Yoshe	A	Bravo	IV
Hallingdal by Kvadrat	E	Whirl	A	Chi	A	Novo	V	Zen	A	Cashmere	III
Hint	C	Wildwood	C	Cienega	B	Ohs	C			Crete	IV
Hush	V	Yanagi	B	Cirque	B	Oodle	III	CRYPTON		Skeet	IV
Idiom	E	Zen by Kvadrat	C	Clayton	C	Oodle+boss	V	PATTERN	GRADE	Fleck	IV
Kilter	V	CRYPTONS:		Cliche	III	Optics	IV	Apropos	A	Glam	IV
Level	D	PATTERN	GRADE	Continuum	B	Optics+boss	V	Brea	A	Independence	III
Loop by Kvadrat	F	Align	B	Cynic	A	Parity	IV	Busybody	A	Kinetic	V
Lore	B	Beside	B	Dabble	V	Parker	IV	Buzz	A	Lustre	IV
Magenta by Kvadrat	D	Blossom	C	Detour	A	Parker+gore	A	Calabasas	B	Max	IV
Marquee	IV	Bop	B	Dreamery	III	Poise	V	Chatterbox	A	Mercury	IV
Medium	III	Briar	C	Dwell	V	Posh	V	Cherish	A	Olympus	IV
Mega by Kvadrat	D	Canopy	C	Echelon	A	Primo	C	Clue	A	Spyro	V
Meridian	B	Chance	C	Elan	A	Prodigy	III	CruX	A	Sublime	IV
Messenger	III	Comment	C	Enigma	B	Prompt	IV	Crypton Suede	V	Surface	V
Milestone	II	Corner	C	Entourage	IV	Proxy	B	Crypton Twill	V	Tatami	IV
		Current	B	Entropy	IV	Pucker	III	Curvy	A	Spirit II	IV
		Dart	C	Enviro	V	Quad	C	Dayspring	A		
		Floret	C	Essentia	A	Quadretti	B	Delmonico	A	DIRECT PRICE	
		Hop	B	Exes	B	Quantum	V	Faze	V	PATTERN	GRADE
		Intertwine	C	Factor	II	Quest	V	Feliz	A	Basis	I
								Flannel	A	Caliber	III

**CF STINSON
VINYL (CONT)**

NaugaLeather	IV	Chroma	B
NaugaSoft	III	Circa	D
Neochrome III	III	Classic Boucle	C
New Duration	IV	Close Knit	B
Oakwood	III	Common Ground	A
Optic w/ AGION *	B	Cotton Duck	IV
Ovation	IV	Counterbalance	C
Oxford	IV	Cross Stitch	F
Patriot Plus II	III	Crystal Pleat	C
Perfection	IV	Cuddle Cloth	F
Petals	A	Decade	D
Phoenix	V	Diamond Plate	A
Pinstripe *	A	Digit/ Digit CR	A
Rally	III	Digit/ Digit CR	A
Rave	A	Double Exposure	E
Renaissance	IV	Dristi	A
Rialto	IV	Echo	D
Rogue II	III	Empire Stripe	E
Scribe	V	English Accent	C
Script	V	Extremes Velvet	B
Sedona *	F	Field Day	C
Shantung	IV	Format	V
Silverado w/ AGION*	B	Forza	A
Simply Square	IV	Fox Trot CR	B
Southampton	IV	Gala	B
Sphere	V	Galo	V
Spirit Millennium	III	Gordian Knot	D
Stat-Con	A	Graffiti Camo	E
Sterling w/ AGION *	A	Grande	A
Stratford	III	Grate	D
Stratosphere	IV	Grid	IV
Surfside	III	Gusto	B
Symphony Classic	IV	Highline	C
Tender *	E	Hologram	E
Tobago	IV	Horizontal	D
Tradition	IV	Hula Hoop	D
Trax	V	In The Loop	F
Tucson	A	Ingot	A
Twilight	IV	Kora	D
Vegas	IV	Kybos	E
Vogue	IV	Luberon	F
Volterra-HC *	F	Luminous	A
Whisper	III	Lunar	D
Whitney	V	Lyric	B
Wink w/ AGION *	A	Mamba	F
Zodiac	IV	Mariner	A
		Market Square	E
		Masquerade	E
		Metaphor	A
		Metro	C
		Mixed Media	E
		Moto	D
		Night Life	C
		Nonchalant CR	B
		Odeon	A
		Panache CR	B
		Piazza	D
		Plus	F
		Pop	A
		Presto	IV
		Quark	C
		Regard	D
		Rib Stitch	D
		Ricochet	A
		Roots & Rhythms	F
		Satellite	E
		Satin Chisel	E
		Sequin	C
		Shibai	E
		Slicker	E
		Spotlight	A

Stacks	V	Eden	B
Star Struck	D	Electron [R]	IV
Starry Night	B	Environs	A
Stepping Stones	E	Essential	III
Swing	B	Filigree [R]	IV
Techno Tweed	C	Flying High	IV
Tides	F	Formula [FR]	V
Tokay II	A	Forte	II
Transit	B	Forum [FR]	V
Transition	C	Foundation	III
Treble CR	E	Foundation [10] [R]	III
Tsunami	E	Framework [R]	V
Tweed Frieze	F	Full Circle [R]	A
Two Step	D	Giovanni	A
Vibe	A	Global FR	A
Vinyl	A	Gothic Tiles *	IV
Wide Angle	C	Greenbriar	IV
Zari	D	Harlequin	IV
Zephyr	A	Harmony {R}	V
Zoom	E	Heritage	IV

**MAYER 2008
GRADE-IN**

		PATTERN	GRADE
A New Era {R}	A		
Abacus	A		
Acanthus	IV		
Agora	V		
Air Mesh	IV		
Alcazar	V		
Arcade	V		
Ascent [FR]	A		
Astro	IV		
Axis	V		
Benefit [R]	V		
Bijou	IV		
Brocade	IV		
Bulls Eye [R]	V		
Cape [10]	IV		
Carat	IV		
Casa	A		
Casbah *	B		
Cathedral *	IV		
Celebration	IV		
Charleston *	IV		
Chateau	A		
Chelsea *	IV		
Clarity	IV		
Classic Velvet	V		
Clematis	IV		
Companion [10]	IV		
Compass	V		
Constructure [R]	IV		
Contrex	V		
Cornerstone	III		
Courtyard	IV		
Crepe (FR)	IV		
Cross Check	II		
Crosstown	IV		
Dabble *	A		
Damask	IV		
Dazzle *	V		
Decade Crepe [10]	IV		
Decade Orion [10]	IV		
Delight *	V		
Denominator [FR] *	IV		
Detail *	V		
Dialogue [10]	IV		
Ditto *	A		
Duraweave® [10]	III		

**KNOLL 2008
GRADE-IN**

		PATTERN	GRADE
3-D	C		
Abacus	A		
Alignment	A		
Analogy	A		
Autobahn	D		
Bank Shot	C		
Beaumont	E		
Calais Cotton Velvet	F		
Camo	E		
Campagna	C		
Cavalier	F		
Charade	C		
Charade HC	D		
Charm	C		
Chess	V		

Eden	B	Waldorf Too [R]	A
Electron [R]	IV	Waste Not {R}	V
Environs	A	Wave Length	III
Essential	III	Wildwood {R}	A
Filigree [R]	IV	FAUX LEATHER	
Flying High	IV	PATTERN	GRADE
Formula [FR]	V	Antelope	A
Forte	II	Antelope Pearl	A
Forum [FR]	V	Antique**	V
Foundation	III	Bayou	B
Foundation [10] [R]	III	Bonanza	B
Framework [R]	V	Caressa [FR]	IV
Full Circle [R]	A	Caressa Suede	IV
Giovanni	A	Dakota	IV
Global FR	A	Doeskin	III
Gothic Tiles *	IV	Florentino	IV
Greenbriar	IV	Fossils	B
Harlequin	IV	Jekyll & Hyde**	V
Harmony {R}	V	Maverick	IV
Heritage	IV	Milano	V
High Society	V	Ostrich Ultra	B
In The Groove	IV	Outback	IV
Insignia	A	Phoenix	V
Interlochen *	IV	Quintessence	D
Jigsaw *	IV	Radiance	IV
Jubilee	IV	Radiance Perf.	IV
Links [R]	IV	Santa Ana	IV
Maya *	IV	Shimmer {R}	B
Merger [FR]	A	Virtually	B
Nebula [R]	V	Virtually Suede	V
North Star [R]	V		
Nylon-Stat ESD	A	GSA Contract -	
Odyssey	V	GS- 28F- 0022P	
Over The Top	IV	Awarded	
Pageant	V	March 15, 2004,	
Paramount	IV	valid thru	
Patio *	B	March 15, 2009	
Perspective FR *	IV		
Petit Point	A		
Pinstripe *	V		
Pisces [R]	V		
Quattro	II		
Regency	IV		
Resolution {R}	V		
Riddle [10]	IV		
Ritz	IV		
Savannah [10]	V		
Segment	V		
Serenade	A		
Side by Side [10]	A		
Solid Ground	A		
Spa	A		
Spacer Mesh	III		
Spirit [10]	A		
Square One	III		
Square Root [10]	V		
Straight & Narrow	IV		
Streamers [10]	V		
Structure	III		
Sunset Strip	III		
Symmetry [10]	V		
Syncopation [10]	A		
Taj	III		
Tangent [FR] *	IV		
Traverse	V		
Trevi *	IV		
Villa	V		
Vineta	III		
Virtually Suede	V		
Vogue *	A		

		PATTERN	GRADE
Aquarius (S)	A		
Atlantis	B		
Awakening	D		
Classic Repp	B		
Classic Velvet	V		
Connections [FR]	A		
Convergence	D		
Deco Motion	A		
Eclipse	B		
Enigma	C		
Giza	D		
Glamour	V		
Illusion	B		
Jumpin' Jacks	B		
Metallurgy	B		
Natural Progression	D		
New Angles	C		
Nylosuede	F		
October's Party	A		
Oracle	B		
Ozone	B		
Paradigm	B		
Reflections	B		
Sakura	C		
Shimmer {R}	B		
Skywriter	C		
Stratosphere	D		
Techno Texture	A		
Times Square	A		

Tranquillity	A	ALEXANDER JULIAN	
Undercurrent	C	COLLECTION	
Vega	B	PATTERN	GRADE
Venetian	F		
Virtually	B		
Volante	F		
		Almost Argyle	C
		Button Down	B
		Cravat	C
		Herringbone	B
		Necktie Stripe	A
		Perfectly Paisley	C
		Play on Plaid	C
		VINYL	
		PATTERN	GRADE
		All Seasons [FR]	IV
		All Use [FR]	III
		Athens [FR]	IV
		Brushed Metals *	A
		Burnished Metals *	A
		Chaps [FR]	IV
		Crystals	A
		Currents	IV
		Dublin Tweed [FR]	V
		Fantasia [FR]	V
		Floral [FR]	IV
		Heather [FR]	IV
		Jamestown	III
		Jive *	A
		Key Largo	IV
		Madrid SP Black	I
		Oxen SP Black	I
		Plainview [FR]	IV
		Polka *	A
		Quadrangle	IV
		Rice Paper [FR]	IV
		Sierra SP Black	I
		Silhouette	IV
		Silk Screen	IV
		Skate	A
		Spirograph	A
		Tiles	IV
		Twill [FR]	IV
		Uptown	V
		Ventura	IV
		Vinyl Stat ESD	A
		Wallaby SP Black	I
		Webscape	A
		WOVEN CRYPTON	
		PATTERN	GRADE
		Accord	A
		Aldine	A
		Altmont	B
		Atelier	C
		Barenthal	B
		BeBop	C
		Boulevard	C
		Branch Out	A
		Bravo	A
		Checkers *	A
		Cheetah Suede	A
		City Lights	B
		Comet	IV
		Fathom	A

Finish Line	B	Linea	V	Guggenheim ©	D	Fortuna	D	Lotus Moon	C	Senna	C
Frequency	E	Mandalay	III	Belenos ©	C	Four Square	C	Luminant	B	Sequence	B
Gem *	A	Mirabel	III	Bennington Too	B	Freeze Frame	D	Masquerade (YD)	D	Shimmy ©	D
Gramercy Park	C	Moxie	V	Biba	F	Frisbee	C	Menswear	A		
Groovy	C	Murios	III	Bliss	C	Fronde Pique		Meridian	B	Sintra -	
Holiday	A	Muzak	V	Bodrum	A	© twenty2	A	Meta Minor	B	Kristie Strasen,	
Hopscotch	C	Parlour	III	Bon Bon	C	Gabrielle	A	Metta	V	© 1998	F
Leafage	B	Plinko	V	Bonnington - © 2005		Galaxy	B	Minuet	D	Skylark	A
Legend *	A	Primary	II	Jocelyn Warner	C	Geodesic	D	Mistral	A	Slick	A
Lyric *	B	Prisma	V	Boreas	D	Go Fish	B	Mono Minor	B	Solar	B
Metro	V	Quartet	II	Bossa Nova	B	Greenbelt	V	© twenty2	B	Solstice	B
Mezzano	B	Rainforest	III	Bounce	A	Grove	F	Montezuma	A	Sonic Plus	C
Mirabella	B	Riblet	V	Bow Line	A	Happenstance- RISD		Moonbeam	A	Sooth	C
Napoli	B	Roundabout	V	Box Lunch-		Collection ©2004	E	Muir	C	Sprocket	D
New Dimensions	E	Sherpa	II	McDonough &		Hara	D	NoHo	A	Square -	
Oxford	B	Shire	II	Braungart	F	Harrington	F	Nolita	A	Guggenheim ©	B
Parkland	B	Sidestep	V	Box Pleat	F	Havana	A	NoMad ©	F	Stacks	C
Posh	A	Sketch	III	Brasserie	A	Henry	A	Odeon	A	Stoplight- RISD	
Promenade	A	Stargaze	V	Breena - Patty		Hide and Seek	C	Ozio	F	Collection ©2004	E
Round 'N Round	C	Starlet	III	Madden Inc. ©	A	High Fiber	F	Palette	E	Sunbeam	B
Runway	C	Stryker	V	Bridge & Tunnel	D	High Plains Drifter	C	Pasa Doble	C	Sunday Shoes	A
Smart Suede	A	Taffeta	III	Brooch	A	Honor Plus	E	Pattino	C	Surface -	
Suede	V	Tartaine	III	Brushstroke	D	Hoxton - © 2005		Perles	A	Guggenheim ©	B
Taffeta Stripe	A	Tom's Garden	V	Busy Bee	V	Jocelyn Warner	C	Pharos ©	E	Sustain	A
Toscana	B	Trapeze	V	Caboose Plus	E	Hue	E	Pigment	F	Swing Set	C
Tracery	A	Trio	II	Café	A	Igneous	IV	Planes ©	F	Taliored Stripe	V
		TV Land	V	Caillou	A	Impasto	F	Plouf	C	Taj	B
		Twirl	V	Calm	C	Implied Block -		Point -		Tango	A
		Versa	III	Cascadia	A	Guggenheim ©	D	Guggenheim ©	D	Taviano ©	C
		Vignette	V	Ce Ce Diamond	A	Implied Circle -		Portier	A	Tea Tree	A
		Wanderlust	V	Closed Loop	A	Guggenheim ©	D	Prairie	A	Terrain	B
		Whitney	III	Clovis	C	Implied Oval -		Prana	C	Terrasse	A
		Wild Palms	IV	Connoisseur III	D	Guggenheim ©	D	Prism	C	Thumbnail Sketch	E
		Wilderness	V	Conservation	A	Improvisation	E	Protect	A	Tinos	C
				Copa	A	Incognito	A	Pueblo	C	Tokens	C
				Cord	A	Incognito Pearl	A	Quixote	A	Toronto	C
				Corolle	A	Inside Edge - © 2005		Radiate	A	Tumbleweed	C
				Croquet	B	Patty Madden Inc.	A	Raffles	B	Tunic	C
				Cube -		Insight Plus	C	Rai- RISD Collection		Tupi	C
				Guggenheim ©	D	lowa/ Ottoman	D	©2004	E	Twill	C
				Dakar	A	Jakarta	A	React	A	V ©	A
				Delphos ©	E	Journey	G	Recess	C	Valet	A
				Details	B	Jungle Gym	C	Reclaim	A	Vento by William	
				Dobby Dot	V	Juxtaposition	C	Reed Stripe	A	McDonough	A
				Dodge ***	V	Kabuki	A	RePeat ©	C	Vibe	A
				Dodge Ball	IV	Kalahari	A	Restore	A	Vlad Lad	B
				Dodge Ball Too	C	Kings Road ©	E	Retreat	C	Water Garden	B
				Dot to Dot	C	Kings Road Too	D	ReUse ©	D	Widget	D
				Double Dutch	C	Klange	B	Rickshaw	D	Wire	E
				Drawing Straws	C	Komposition	A	Rising Sun Plus	A	Wishbone	V
				Dwell	B	Kuma	E	Rivergrass by		Wobble	A
				Eero-Port- RISD		Lagoon	A	Susan Lyons	A	Wool Suede Too	C
				Collection ©2004	E	Lalique	C	Rook	A	Woven Clutch	A
				Encaustic	E	Laureate	B	Room Service ©	C	Yarn	D
				Epiphany	A	Leafette - Patty		Rotolo	D	You Are What You	
				Eureka Too	A	Madden Inc. ©	A	Rough & Ready ©	A	Eat- McDonough	
				Excelsior	V	Lexicon	C	Round About	C	& Braungart	F
				Faconne	B	Lillian ©	E	Sabara Plus ©	C	Yucatan	A
				Falling Leaves ©	E	Line Item	C	Sam ©	B	Ziggurat	C
				Figure Eight - © 2005		Lolol	B	Samba	D	Zocalo	C
				Patty Madden Inc.	A	Lorien	D	Sandbox	A		
				Focus	E	Loseta - Kristie		Saranac ©	B		
				Fonte	A	Strasen, © 1998	D	See Saw	C		

**DOUGLASS/
ABSECON
GRADE-IN**

PATTERN GRADE

Allure	III
Arena	V
Ashbury	V
Ashley	III
Athena	IV
Audra	III
Bandeau	V
Baskerville	V
Bastile	II
Beacon	III
Bedelia	III
Bliss	III
Britta	III
Calista	III
Channel	II
Cirque	V
Coronado	V
Daktari	V
Daze	III
Del Mar	III
Delano	III
Domaine	V
Dovetail	III
Duet	II
Ensemble	II
Flame	III
Foundation	III
Icon	III
Kinetic	III
Kudos	III
Lair	V
Legend	IV

**DESIGN TEX
GRADE-IN**

PATTERN	GRADE
AbEx ©	D
Acacia	B
Ace - © 2003 Laura	
Guido-Clark	D
Agapetos	A
Agave	C
Alaya	C
Alethos Plus	D
Alkai	C
Allure	A
Alpha	IV
Amuse	B
Aphelion	B
Appleseed	A
Argyle Socks	A
Arlington - © 2005	
Jocelyn Warner	C
Artist's Canvas	IV
Astrid	A
Auberge	A
Busy Bee	V
Barnsbury - © 2005	
Jocelyn Warner	C
Battista	E
Beam -	

[FR] = Fire Resistant • {R} Recycled ECO SYSTEM Collection® • Decade or [10] = a 10 year warranty - See swatch card for details

* ITEMS ARE BEING PHASED OUT SO STOCK OUTS ARE POSSIBLE. PLEASE CALL **MAYER FABRICS** CUSTOMER SERVICE FOR AVAILABILITY.

**Jekyll & Hyde and Antique are designed to simulate a natural leather that features shade variation and "beauty marks" formed from wrinkles, stretch marks and usage. The effects that will occur with this Faux Leather product are purposefully intended to mimic those of real leather and are not defects in the product.

CHROMCRAFT MECHANISM FUNCTIONS 2007-2008

The mechanism numbers listed below can be found in each Chromcraft chair model number per the example shown: X381-**770**-77 when applicable this number will always represent the mechanism and base combination found on existing Chromcraft chairs.

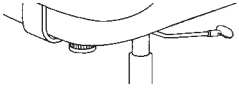

099 is a basic task mechanism, swivels 360°, height adjustable gas cylinder. The chair back is attached via a j-bar that allows for horizontal adjustment of the chair back.

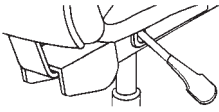

095/E95 is a swivel tilt w/lock mechanism that is tension adjustable. Chair swivels 360°. Height adjustment is via gas cylinder, chair back is attached via a non adjustable j-bar that comes complete with a ratchet back mechanism for back height adjustment from a seated position. Seat and back tilt as one unit and lock in an upright position only.

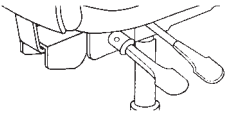

051/E51/E15/215 is a synchro task mechanism that allows the chair user to adjust the seat and back angle with a single lever at a 2 to 1 ratio. Once the seat and back are adjusted to the desired position the lever is pressed downward locking the current position. Mechanism is tension adjustable. Height adjustment is via a gas cylinder. The seat and back move as one unit at a 2 to 1 ratio in the unlock position. Chair swivels 360°. The chair back is attached with a non adjustable j-bar complete with a ratchet back mechanism that allows the user to adjust the back height from a seated position.

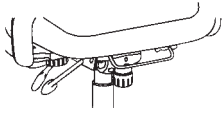

054/E54 is an asynchronous multi-function task mechanism complete with a seat slider. This mechanism uses independent levers to adjust the seat angle (right side seated) and a separate lever (left side seated) to adjust for infinite back angle adjustment. This mechanism also has an auto style seat slider located underneath the front edge of the seat. Chair swivels 360°. Height adjustment is via a gas cylinder. The chair back is attached with a non adjustable j-bar complete with a ratchet back mechanism that allows the user to adjust the back height from a seated position.

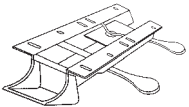

085 is a posture back mechanism that provides 360° swivel, along with an infinite back angle locking mechanism.

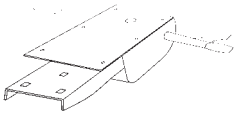

091/E91 is a unique side tension mech referred to as the “Revo” mechanism. This is a posture back mechanism with a 2.5 to 1 seat to back recline ratio. The side tension mechanism is easily adjusted from a seated position. The mechanism features a 5 position lock feature for multiple lock positions.

435 are 360° mechanisms with a pneumatic height adjustment. This mech is used on ISO stools only.

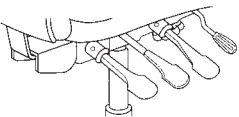

551/493 is a multi-function task intensive asynchronous mechanism that allows for an infinite range of adjustments and movements. Mechanism features include: 360° swivel, independent seat angle adjustment, independent infinite back angle adjustment, seat pivots in a 5° forward position, infinite position tilt lock, seat and back free floats as a single unit when unlocked, tilt is tension adjustable. Height adjustment is via a gas cylinder. The chair back is attached with a non adjustable j-bar complete with a ratchet back mechanism that allows the user to adjust the back height from a seated position.

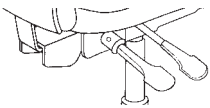

445/492 is an articulating task mechanism that allows the chair user to adjust the seat angle and back angle from a single lever; once the seat and back are correctly positioned the lever is pressed downward into a locking position. Infinite angle lock adjustment, 5° forward pitch of the seat can be achieved in unlock position. Chair swivels 360°. Height adjustment is via a gas cylinder. The chair back is attached with a non adjustable j-bar complete with a ratchet back mechanism that allows the user to adjust the back height from a seated position.

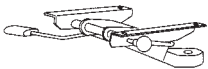

491 (Ultima only) is a posture back mechanism that operates on a 2 to 1 ratio for a smooth almost effortless ride. Chair swivels 360°. Height adjustment is via a gas cylinder. Tilt tension control. Upright position tilt lock out feature.

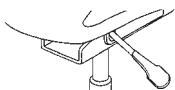

121 is a swivel tilt mechanism with an upright locking feature. Chair swivels 360°. Tilt tension adjustment control. Seat and back tilt as one unit in the unlocked position. Comes with an arm attachment bracket this mech is used on Pliant ST only. Height adjustment is via gas cylinder.



JRY-77 is a floor mounted swivel-return mechanism that is used with Chromcraft’s Quest and Solas Management chair versions to create a jury base unit. This mechanism allows the chair to turn 30° left or right then automatically return the chair to center position when unoccupied. Mechanism maintains consistent 19” seat height. This mechanism requires qualified professional installation to end users facility and will require additional hardware for floor mounting purposes dependent upon the floor substrate.

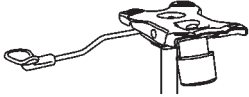

116/120/136/150/220/260/420 is a mid pivot swivel tilt mechanism with an upright locking feature. Chair swivels 360°. Tilt tension adjustment control. Seat and back tilt as one unit in the unlocked position. Height adjustment is via gas cylinder.

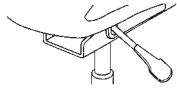

170 is a mid pivot swivel tilt mechanism with an upright locking feature. Chair swivels 360°. Tilt tension adjustment control. Seat and back tilt as one unit in the unlocked position. Height adjustment is via gas cylinder.

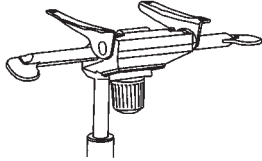

840/850/450/770/780/290/190/110/130/140 is a knee-tilt tension adjustable mechanism used in executive and management seating. Knee-tilt mechanisms provide a more forward pivot or break point which reduces the rise of the front seat edge. The reduction in seat front seat rise assists the user by keeping their feet on the floor which promotes better circulation and all day comfort. Other features include: Chair swivels 360°. Tilt tension adjustment control. Upright position has tilt lock feature. The mechanism can be locked in 5 positions to accommodate user. Seat and back tilt as one unit in the unlocked position. Height adjustment is via gas cylinder.

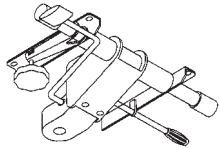

870/880/890 is a knee-tilt torsion bar adjustable mechanism used in executive and management seating. Knee-tilt mechanisms provide a more forward pivot or break point which reduces the rise of the front seat edge. The reduction in seat front seat rise assists the user by keeping their feet on the floor which promotes better circulation and all day comfort. Other features include: Chair swivels 360°. Tilt tension adjustment control. Upright position has tilt lock feature. Seat and back tilt as one unit in the unlocked position. Height adjustment is via gas cylinder.

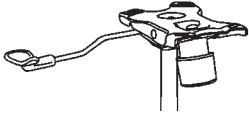

180/280 is a swivel tilt w/lock mechanism that is tension adjustable. The mechanism has a single lever located on the right side that controls the pneumatic height control and the locking/unlocking function. Chair swivels 360°. Height adjustment is via gas cylinder, chair back is attached via a non adjustable j-bar. Seat and back tilt as one unit and lock in an upright position only.

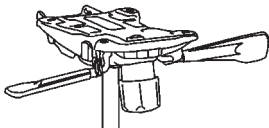

181/231/281 is a synchro task mechanism that allows the chair user to adjust the seat and back angle to achieve a two to one ratio when unlocked. Using the same lever located on the left side the seat and back once adjusted to the desired position can be locked into position. The mechanism is tension adjustable. Height adjustment is via a gas cylinder with the lever located on the right side seated. Chair swivels 360°. The chair back is attached with a double non adjustable j-bar.

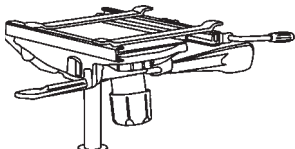

184/284 is a synchro task mechanism with a seat slider that allows the chair user to adjust the seat and back angle to achieve a two to one ratio when unlocked. Using the same lever located on the left side the seat and back once adjusted to the desired position can be locked into position. The seat slider is located on the left side just above the mechanism control and allows the user a two inch seat adjustment. The mechanism is tension adjustable. Height adjustment is via a gas cylinder with the lever located on the right side seated. Chair swivels 360°. The chair back is attached with a double non- adjustable j-bar.

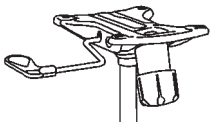

230 is a swivel tilt with lock mechanism that is tension adjustable. Chair swivels 360°. Height adjustment is via gas cylinder, chair back is attached via a non adjustable j-bar. Seat and back tilt as one unit and lock in an upright position only.

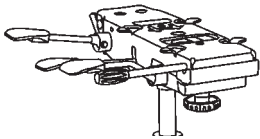

232 is an asynchronous multi-function task mechanism. This mechanism uses independent levers to adjust the seat angle (right side seated) and a separate lever (right side seated) to adjust for infinite back angle adjustment. On the right side seated is a forward pitch adjustment which can be adjusted from 0° to 5° maximum. Chair swivels 360°. Height adjustment is via a gas cylinder. The chair back is attached with a non adjustable j-bar complete with a ratchet back mechanism that allows the user to adjust the back height from a seated position.

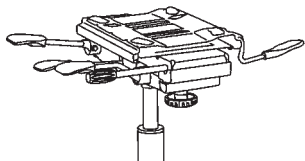

234 is an asynchronous multi-function task mechanism complete with a seat slider. This mechanism uses independent levers to adjust the seat angle (right side seated) and a separate lever (right side seated) to adjust for infinite back angle adjustment. On the right side seated is a forward pitch adjustment which can be adjusted from 0° to 5° maximum. This mechanism also has a seat slider located on the left side near the front of the seat. Chair swivels 360°. Height adjustment is via a gas cylinder. The chair back is attached with a non adjustable j-bar complete with a ratchet back mechanism that allows the user to adjust the back height from a seated position.

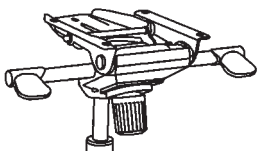

185 is a knee-tilt tension adjustable mechanism. Knee-tilt mechanisms provide a more forward pivot or break point which reduces the rise of the front seat edge. The reduction in seat front seat rise assists the user by keeping their feet on the floor which promotes better circulation and all day comfort. Other features include: Chair swivels 360°. Tilt tension adjustment control. The mechanism can be locked in 5 positions to accommodate the user's personal seating preference. The seat and back tilt as one unit in the unlocked position. Height adjustment is via gas cylinder.



ME

• ME chairs provide that all day comfort and support at a very attractive price. • Simple, yet elegant, functional yet sophisticated....that's ME!
 • ME chairs are available in a variety of mechanisms, arm styles, and back heights. • With stylish upholstered outer backs and plush ergonomically shaped seats and inner backs there is a ME chair just right for your seating needs. • With fixed stationary arms ME can be used in any executive or conference setting with ease. • Outfitted with T arms ME is at home as a task oriented chair. T arms are available fixed or adjustable height. • ME chairs are available with three distinct mechanisms. There is a simple swivel tilt with lock for executive, conferencing and general office use. A Synchro mechanism allows simple adjustments for tasking at an affordable price. The asynchronous mechanism allows the user to make independent adjustments to the seat and back by using designated handles for easy adjustments. The asynchronous mechanism can also be fitted with an optional seat slider for a wider range of adjustments. • When you have seating needs...you'll have to agree it's all about ME!

Illustration	Item Number	Description	Arms	Price and Upholstery Availability					
				Grade I	COM Grade II	Grade III	Grade IV	Grade V	Grade LM
	Y501 230 77	High Back swivel / tilt lock / unlock	No arms	395	406	426	443	462	544
	Y521 230 77		fixed "T" arm	468	482	507	527	550	648
	Y531 230 77		vertical adj arms	498	512	537	558	580	683
	Y551 230 77		fixed urethane arm	425	438	459	477	497	585
	Y501 231 77	High Back synchro mech	No arms	434	447	468	487	508	598
	Y521 231 77		fixed "T" arm	508	523	550	572	596	702
	Y531 231 77		vertical adj arms	538	553	580	602	628	740
	Y551 231 77		fixed urethane arm	464	478	502	521	543	639
	Y501 232 77	High Back Asynchronous mech	No arms	474	488	512	532	555	653
	Y521 232 77		fixed "T" arm	534	550	568	591	627	738
	Y531 232 77		vertical adj arms	564	580	608	631	658	775
	Y551 232 77		fixed urethane arm	504	518	542	563	587	691
	Y501 234 77	High Back Asynchronous w/seat slider	No arms	496	509	534	555	578	680
	Y521 234 77		fixed "T" arm	557	574	593	627	654	770
	Y531 234 77		vertical adj arms	587	604	633	658	686	808
	Y551 234 77		fixed urethane arm	526	541	568	591	616	726
	Y503 230 77	Mid Back swivel / tilt lock / unlock	No arms	369	389	409	426	444	524
	Y523 230 77		fixed "T" arm	449	463	487	506	528	623
	Y533 230 77		vertical adj arms	479	493	517	538	562	663
	Y553 230 77		fixed urethane arm	399	419	439	456	476	562
	Y503 231 77	Mid Back synchro mech	No arms	415	428	449	468	488	576
	Y523 231 77		fixed "T" arm	490	505	531	553	577	681
	Y533 231 77		vertical adj arms	520	535	561	584	610	720
	Y553 231 77		fixed urethane arm	445	458	481	500	522	616
	Y503 232 77	Mid Back Asynchronous mech	No arms	455	469	492	512	535	632
	Y523 232 77		fixed "T" arm	525	541	569	593	619	731
	Y533 232 77		vertical adj arms	555	571	599	623	649	766
	Y553 232 77		fixed urethane arm	485	499	524	545	568	670
	Y503 234 77	Mid Back Asynchronous w/seat slider	No arms	478	493	519	540	563	664
	Y523 234 77		fixed "T" arm	544	561	590	614	641	756
	Y533 234 77		vertical adj arms	574	591	620	644	671	792
	Y553 234 77		fixed urethane arm	508	523	549	572	596	704

ARM DESCRIPTION

Fixed "T" Arm T-Arms no adjustments	Vertical Adj Arms T-Arms fully adjustable	Fixed Arm Nylon Arms no adjustments

Numbers below indicate mechanism and base associated per chair series.

Mechanisms

- 230 Swivel tilt control, adjustable tension
- 231 Synchro control adjusts seat and back at 2 to 1 ratio with single lever
- 232 Asynchronous control adjusts seat, back with separate levers with seat angle adjustment and seat slider
- 234 Asynchronous control adjusts seat, back with separate levers with seat angle adjustment





Finishes Available: • Black - 77

Grade-In Prices and Availability						Approximate Overall Size			Seat		Ht. From Floor		Approx. Weight, Pack & Cube Ydg. Req.
Grade A	Grade B	Grade C	Grade D	Grade E	Grade F	W	D	H	W	D	Seat	Arm	
532	548	563	579	595	611	26"	26"	37½"	21½"	18"	17½"	24½" to 27⅞"	28 lbs. 1 PK KD 12.60 cu 2¼ yds
620	636	651	667	683	699			to			to		
650	666	681	697	713	729			43½"			21"		
567	583	598	614	630	646								
578	594	609	625	641	657	26"	26"	37½"	21½"	18"	16½"	22⅝" to 26⅝"	28 lbs. 1 PK KD 12.60 cu 2¼ yds
666	682	697	713	729	745			to			to		
698	714	729	745	761	777			43½"			20"		
613	629	644	660	676	692								
625	641	656	672	688	704	26"	26"	39¼"	21½"	18"	17½"	23⅜" to 27⅞"	28 lbs. 1 PK KD 12.60 cu 2¼ yds
697	713	728	744	760	776			to			to		
728	744	759	775	791	807			45¼"			21"		
657	673	688	704	720	736								
648	664	679	695	711	727	26"	26"	40½"	21½"	18"	18½"	24⅜" to 28⅜"	29 lbs. 1 PK KD 12.60 cu 2¼ yds
724	740	755	771	787	803			to			to		
756	772	787	803	819	835			46¼"			22"		
686	702	717	733	749	765								
514	530	545	561	577	593	26"	26"	33½"	21½"	18"	17½"	24½" to 27⅞"	27½ lbs. 1 PK KD 12.60 cu 2 yds
598	614	629	645	661	677			to			to		
632	648	663	679	695	711			39¼"			21"		
546	562	577	593	609	625								
558	574	589	605	621	637	26"	26"	33"	21½"	18"	16½"	22⅝" to 26⅝"	27½ lbs. 1 PK KD 12.60 cu 2 yds
647	663	678	694	710	726			to			to		
680	696	711	727	743	759			39"			20"		
592	608	623	639	655	671								
605	621	636	652	668	684	26"	26"	35"	21½"	18"	17½"	23⅜" to 27⅞"	27½ lbs. 1 PK KD 12.60 cu 2 yds
689	705	720	736	752	768			to			to		
719	735	750	766	782	798			41"			21"		
638	654	669	685	701	717								
633	649	664	680	696	712	26"	26"	35"	21½"	18"	18½"	24⅜" to 28⅜"	28½ lbs. 1 PK KD 12.60 cu 2 yds
711	727	742	758	774	790			to			to		
741	757	772	788	804	820			42"			22"		
666	682	697	713	729	745								



TRAK

• Combining high tech design and comfort, TRAK achieves the best of all seating types. • The desk chair is available in three styles, high-back with a head rest, high-back without a headrest, mid-back task plus a matching guest chair. • TRAK makes an innovative design statement, with its state of the art mesh back, and exoskeleton steel frame. • The cool mesh back promotes continuous air flow keeping the end-user comfortable. • The molded foam seat keeps them properly supported for hours of use. • TRAK delivers comfort and value with optional fabrics available for the seat and headrest to blend or contrast with the black mesh back. • TRAK arms are adjustable for multiple positioning and include a pivoting arm cap to aid in tasking functions. • TRAK chairs deliver support and unequalled comfort with its unique 10 TRAK Adjustment System. • With 10 custom adjustments, the end-user can always find the perfect fit for any task.

Illustration	Item Number	Description	Price and Upholstery Availability					
			Grade I	COM Grade II	Grade III	Grade IV	Grade V	Grade LM
	X280 185 77	Executive Chair With Headrest tilt-lock, knee tilt	849	862	879	894	908	1,038
	X281 185 77	Executive Chair tilt-lock knee tilt	749	759	772	784	795	905
	X283 185 77	Management Chair tilt-lock knee tilt	699	709	722	734	745	855
	X287 187 77	Guest Chair sled frame	669	679	692	704	715	825

Ten Adjustments System:

- Seat height • Chair Swivel • Seat Tilt • Seat Tilt Tension • Arm Height
- Arm Width • Arm Pivot • Lumbar Height • Headrest Height • Headrest Depth

Finishes Available: • Black - 77

Grade-In Prices and Availability							Approximate Overall Size			Seat Overall Size		Back Overall Size		Ht. From Floor		Approx. Weight, Pack & Cube Ydg. Req.
Grade A	Grade B	Grade C	Grade D	Grade E	Grade F	W	D	H	W	D	W	D	Seat	Arm		
937	943	949	955	962	968	26½	25½	52½ to 45½	20	20	20	22	21 to 18	31½ to 26¾	60 lbs. 1 PK SU 18.2 CU - 1 yd	
819	824	829	834	840	845	26½	25½	41½ to 38½	20	20	20	22	21 to 18	31½ to 26¾	57 lbs. 1 PK SU 15.5 CU - ¾ yd	
769	774	779	784	790	795	26½	24	39 to 36	20	20	18¾	19½	21 to 18	32 to 27	55 lbs. 1 PK SU 15.5 CU - ¾ yd	
739	744	749	754	760	765	26½	25	37	20	20	20	22	17½	28½ to 26	46 lbs. 1 PK SU 15.5 CU - ¾ yd	



ULTIMA II

- Molded and multicontoured seat and back foam • Class 4 gas cylinder
- Outer back is textured polypropylene
- Arms are adjustable with pads of urethane over steel
- Base is molded-in glass reinforced co-polymer

Illustration	Item Number	Description	Price and Upholstery Availability					
			Grade I	COM Grade II	Grade III	Grade IV	Grade V	Grade LM
	Y432 491 77	Executive Posture Back Knee Tilt Upholstered Outer Back	781	794	840	872	911	1,106
	Y434 491 77	Management Posture Back • Knee Tilt Upholstered Outer Back	756	767	813	847	885	1,079
	Y434 493 77	Management Fully Adjustable Upholstered Outer Back • Adj. Back	767	781	827	859	900	1,093
	Y414 493 77	Management Fully Adjustable Adjustable Arms • Upholstered Outer Back • Adj. Back	819	833	878	911	950	1,145
	Y401 551 77	High Back • Fully Adjustable Task Chair • Gas Lift • Armless	690	704	736	761	794	N/A
	Y401 492 77	High Back Task Chair Articulating Mechanism Gas Lift • Armless	624	638	670	695	729	N/A
	Y411 551 77	High Back • Fully Adjustable Task Chair • Gas Lift • Urethane Arm Pad	794	807	840	865	900	N/A
	Y411 492 77	High Back • Task Chair Articulating Mechanism Gas Lift • Urethane Arm Pad	729	742	776	800	833	N/A
	Y403 551 77	Low Back • Fully Adjustable Task Chair • Gas Lift • Armless	665	676	710	736	767	N/A
	Y403 492 77	Low Back • Task Chair Articulating Mechanism Gas Lift • Armless	599	613	646	670	704	N/A
	Y413 551 77	Low Back • Fully Adjustable Task Chair • Gas Lift • Urethane Arm Pad	767	781	813	840	872	N/A
	Y413 492 77	Low Back • Task Chair Articulating Mechanism Gas Lift • Urethane Arm Pad	704	717	747	776	807	N/A
	Y427 151 77	Guest Chair • Upholstered Arm Pad	432	444	472	500	528	N/A
	Z403 445 77	Stool Armless	690	704	736	761	794	N/A
	Z413 445 77	Stool Arms	794	807	840	865	900	N/A

PATTERNS NOT AVAILABLE ON THIS SERIES: REGAL

For soft dual wheel casters add suffix letter "K" to model number
example: Y101 051 77**K** and add **\$28** to list price above.

Numbers below indicate mechanism and base associated per chair series.

Mechanisms

491 is a posture back control with lock out device. • 551/493 has independent seat and back control levers no seat slider
492/445 adjusts seat and back with single lever

Finishes Available: • Black - 77

See page 10 for mechanism information.

Grade-In Prices and Availability						Approximate Overall Size			Seat		Ht. From Floor		Approx. Weight, Pack & Cube Ydg. Req.
Grade A	Grade B	Grade C	Grade D	Grade E	Grade F	W	D	H	W	D	Seat	Arm	
985	1,002	1,018	1,035	1,052	1,068	25	28	46 ³ / ₄ to 41	22 ¹ / ₂	19 ¹ / ₂	23 ³ / ₄ to 18	30 ³ / ₄ to 25	45 lbs. 1 CTN SU 19.5 CU - 2 ¹ / ₄ yds
959	976	992	1,009	1,026	1,043	24 ¹ / ₂	27 ¹ / ₂	42 ³ / ₄ to 37 ¹ / ₄	20	19	23 ³ / ₄ to 18	30 ³ / ₄ to 25	56 lbs. 1 CTN SU 14.7 CU - 2 yds
974	991	1,007	1,024	1,041	1,058	24 ¹ / ₂	27 ¹ / ₂	41 ¹ / ₂ to 36	20	19	22 ¹ / ₂ to 17	29 ¹ / ₂ to 24	56 lbs. 1 CTN SU 14.7 CU - 2 yds
1,024	1,041	1,057	1,074	1,091	1,108	28 to 25 ¹ / ₄	27 ¹ / ₂	41 ¹ / ₂ to 36	20	19	22 ¹ / ₂ to 17	29 ¹ / ₂ to 24	56 lbs. 1 CTN SU 14.7 CU - 2 yds
851	865	878	890	904	917	22	24 ¹ / ₂	41 ¹ / ₂ to 35	19	19	20 ¹ / ₂ to 16 ¹ / ₂	—	45 lbs. 1 CTN KD 10.4 CU - 1 ³ / ₄ yds
787	800	813	826	840	852	22	24 ¹ / ₂	41 ¹ / ₂ to 35	19	19	20 ¹ / ₂ to 16 ¹ / ₂	—	45 lbs. 1 CTN KD 10.4 CU - 1 ³ / ₄ yds
957	971	984	996	1,010	1,023	27 to 24 ¹ / ₄	24 ¹ / ₂	41 ¹ / ₂ to 35	19	19	20 ¹ / ₂ to 16 ¹ / ₂	30 to 23 ¹ / ₂	55 lbs. 1 CTN KD 10.4 CU - 1 ³ / ₄ yds
890	904	917	930	943	956	28 to 25 ¹ / ₂	24 ¹ / ₂	41 ¹ / ₂ to 35	19	19	20 ¹ / ₂ to 16 ¹ / ₂	30 to 23 ¹ / ₂	55 lbs. 1 CTN KD 10.4 CU - 1 ³ / ₄ yds
825	838	851	864	878	890	22	24 ¹ / ₂	39 to 32 ¹ / ₂	19	19	20 ¹ / ₂ to 16 ¹ / ₂	—	45 lbs. 1 CTN KD 10.4 CU - 1 ¹ / ₂ yds
761	775	788	800	814	827	22	24 ¹ / ₂	39 to 32 ¹ / ₂	19	19	20 ¹ / ₂ to 16 ¹ / ₂	—	45 lbs. 1 CTN KD 10.4 CU - 1 ¹ / ₂ yds
930	943	956	969	983	995	28 to 25 ¹ / ₂	24 ¹ / ₂	39 to 32 ¹ / ₂	19	19	20 ¹ / ₂ to 16 ¹ / ₂	30 to 23 ¹ / ₂	55 lbs. 1 CTN KD 10.4 CU - 1 ¹ / ₂ yds
864	878	890	903	917	930	28 to 25 ¹ / ₂	24 ¹ / ₂	39 to 32 ¹ / ₂	19	19	20 ¹ / ₂ to 16 ¹ / ₂	30 to 23 ¹ / ₂	55 lbs. 1 CTN KD 10.4 CU - 1 ¹ / ₂ yds
585	599	612	624	638	651	21 ¹ / ₄	25 ¹ / ₂	35 ¹ / ₂	19 ¹ / ₂	19	18 ¹ / ₂	26 ¹ / ₄	32 lbs. 1 CTN SU 12.5 CU - 2 yds
851	865	878	890	904	917	22	27 ¹ / ₂	46 ¹ / ₂ to 39 ³ / ₄	19	19	30 ³ / ₄ to 25 ³ / ₄	—	52 lbs. 1 CTN SU 15.5 CU - 1 ¹ / ₂ yds
957	971	984	996	1,010	1,023	28 to 25 ¹ / ₂	27 ¹ / ₂	46 ¹ / ₂ to 39 ³ / ₄	19	19	30 ³ / ₄ to 25 ³ / ₄	39 ³ / ₄ to 34 ³ / ₄	67 lbs. 1 CTN SU 15.5 CU - 1 ¹ / ₂ yds



GENESIS

- Three back height designs • Multiple mechanisms ranging from basic task to asynchronous with seat slider • Arm options: vertical adjustment only; fully adjustable; fully adjustable with pivoting pads • Heavy duty casters are standard • Class 4 gas cylinder provides weight capacity in excess of 400 pounds • Molded contoured Ultrafoam "modified tractor" seat design standard • Molded contoured Ultrafoam back for ergonomic fit • Ratchet mechanism back height adjustment from a seated position

Illustration	Item Number	Description	Arms	Price and Upholstery Availability					
				Grade I	COM Grade II	Grade III	Grade IV	Grade V	Grade LM
24/7 QS 	Y101 051 77	High Back,	no arms	541	553	584	615	642	
	Y111 051 77	syncro mech	fully adj w/pivot pads	660	674	705	735	761	
	Y131 051 77		vertical adj only	617	629	660	690	718	
	Y141 051 77		fully adjustable	648	660	692	721	749	
24/7 QS	Y101 054 77	High Back,	no arms	581	594	625	654	683	
	Y111 054 77	Asyncro mech	fully adj w/pivot pads	701	713	745	774	802	
	Y131 054 77	w/seat slider	vertical adj only	656	671	701	730	758	
	Y141 054 77		fully adjustable	689	701	733	761	790	
QS	Y101 091 77	High Back,	no arms	570	582	614	643	672	
	Y111 091 77	posture mech	fully adj w/pivot	690	702	734	762	791	
	Y131 091 77		vertical adj arms	645	657	689	718	746	
	Y141 091 77		fully adj/no pivot	677	690	721	750	779	
24/7 QS	Y103 051 77	Mid Back,	no arms	483	494	526	555	583	
	Y113 051 77	syncro mech	fully adj w/pivot pads	603	616	647	676	703	
	Y133 051 77		vertical adj only	558	571	603	631	658	
	Y143 051 77		fully adjustable	588	603	633	664	691	
24/7 QS	Y103 054 77	Mid Back,	no arms	517	530	562	591	619	
	Y113 054 77	Asyncro mech	fully adj w/pivot pads	639	650	683	711	740	
	Y133 054 77	w/seat slider	vertical adj only	594	607	639	667	694	
	Y143 054 77		fully adjustable	625	639	671	697	726	
QS	Y103 085 77	Mid Back,	no arms	483	494	525	555	583	
	Y113 085 77	posture back	fully adj w/pivot	603	615	646	676	703	
	Y133 085 77		vertical adj arms	558	571	603	631	659	
	Y143 085 77		fully adj/no pivot	589	603	633	663	691	
QS	Y103 091 77	Mid Back,	no arms	506	518	550	579	608	
	Y113 091 77	posture mech	fully adj w/pivot	626	640	671	698	727	
	Y133 091 77		vertical adj arms	582	595	626	655	684	
	Y143 091 77		fully adj/no pivot	614	626	657	687	715	
24/7 QS	Y103 099 77	Mid Back,	no arms	378	391	423	453	481	
	Y113 099 77	non-tilt mech	fully adj w/pivot pads	498	511	545	572	600	
	Y133 099 77	(back in/	vertical adj only	455	467	500	528	555	
	Y143 099 77	out only)	fully adjustable	487	500	530	560	586	
24/7 QS	Y105 051 77	Low Back,	no arms	467	481	511	541	569	
	Y115 051 77	syncro mech	fully adj w/pivot pads	586	600	631	660	689	
	Y135 051 77		vertical adj only	545	555	586	617	644	
	Y145 051 77		fully adjustable	574	586	619	648	676	
24/7 QS	Y105 054 77	Low Back,	no arms	503	515	548	577	604	
	Y115 054 77	Asyncro mech	fully adj w/pivot pads	623	634	667	695	723	
	Y135 054 77	w/seat slider	vertical adj only	579	591	623	651	679	
	Y145 054 77		fully adjustable	611	623	654	684	711	

PATTERNS NOT AVAILABLE ON THIS SERIES: REGAL

For soft dual wheel casters add suffix letter "K" to model number
example: Y101 051 77K and add \$28 to list price above.

24/7 Recommended for Intensive use.

QS Ships in 2 days in selected fabrics. See 2-Day QuickShip Brochure.

Numbers below indicate mechanism and base associated per chair series.

Mechanisms

099 Basic task control, swivels, gas cylinder, horizontal back adjustment • 095 Swivel tilt control, adjustable tension

051 Synchro control adjusts seat and back at 2 to 1 ratio with single lever

054 Asynchronous control adjusts seat and back with separate levers with seat slider

Finishes Available: • Black - 77

See page 10 for mechanism information.

Grade-In Prices and Availability						Approximate Overall Size			Seat		Ht. From Floor		Approx. Weight, Pack & Cube Ydg. Req.
Grade A	Grade B	Grade C	Grade D	Grade E	Grade F	W	D	H	W	D	Seat	Arm	
697	711	723	735	748	761	25		46.75			21.5	--	32
817	830	843	855	867	881		25	to	20.5	18	to	28.5	36
774	787	799	812	824	837	26.5		43			17.75	to	1 PK SU
804	818	830	843	855	868							24.75	16.7 cu - 1¼ yds
739	752	764	777	789	802	25		46.75			21.5	--	32
858	871	884	896	908	922		25	to	20.5	18	to	28.5	40
814	827	839	852	864	878	26.5		43			17.75	to	1 PK SU
846	859	871	884	896	909							24.75	16.7 cu - 1¼ yds
727	741	753	765	778	791	25		46.75			21.5	--	32
847	860	872	885	897	911		25	to	20.5	18	to	28.5	36
801	815	827	839	852	865	26.5		43			17.8	to	1 PK SU
834	848	860	872	885	898							24.8	16.7 cu - 1¼ yds
631	642	653	663	675	685	25		40.25			21.5	--	28
752	762	774	784	795	805		25	to	20.5	18	to	28.5	32
707	717	728	739	750	760	26.5		36.5			17.75	to	1 PK KD
740	750	761	771	783	793							24.75	10.3 cu - 1¼ yds
667	678	689	699	711	721	25		40.25			21.5	--	32
788	798	810	820	831	842		25	to	20.5	18	to	28.5	36
743	753	764	775	786	796	26.5		36.5			17.75	to	1 PK KD
775	785	796	806	818	828							24.8	10.3 cu - 1¼ yds
631	642	653	663	675	685	25		40.3			21.5	--	28
752	762	774	784	795	805		25	to	20.5	18	to	28.5	32
708	718	729	740	751	761	26.5		36.5			17.8	to	1 PK KD
740	750	761	771	783	793							24.8	10.3 cu - 1¼ yds
656	666	678	688	699	710	25		40.25			21.5	--	28
776	786	797	808	819	829		25	to	20.5	18	to	28.5	32
732	743	754	764	776	786	26.5		36.5			17.75	to	1 PK KD
763	774	785	795	806	817							24.75	10.3 cu - 1¼ yds
529	540	551	561	573	583	25		40.25			21.5	--	28
649	659	671	681	692	702		25	to	20.5	18	to	28.5	32
604	614	625	636	647	657	26.5		36.5			17.75	to	1 PK KD
634	645	656	666	678	688							24.75	10.3 cu - 1¼ yds
617	627	639	649	660	671	25		36.75			21.5	--	28
737	748	759	769	781	791		25	to	20.5	18	to	28.5	32
692	702	714	724	735	746	26.5		33			17.75	to	1 PK KD
724	734	746	756	767	778							24.75	10.3 cu - 1¼ yds
652	662	674	684	695	706	25		36.75			21.5	--	32
771	782	793	803	815	825		25	to	20.5	18	to	28.5	36
727	737	749	759	770	781	26.5		33			17.75	to	1 PK KD
759	769	781	791	802	813							24.75	10.3 cu - 1¼ yds

Continued on next page...



GENESIS

- Three back height designs • Multiple mechanisms ranging from basic task to asynchronous with seat slider • Arm options: vertical adjustment only; fully adjustable; fully adjustable with pivoting pads • Heavy duty casters are standard • Class 4 gas cylinder provides weight capacity in excess of 400 pounds • Molded contoured Ultrafoam "modified tractor" seat design standard • Molded contoured Ultrafoam back for ergonomic fit • Ratchet mechanism back height adjustment from a seated position

Illustration	Item Number	Description	Arms	Price and Upholstery Availability					
				Grade I	COM Grade II	Grade III	Grade IV	Grade V	Grade LM
	Y105 085 77	Low Back	no arms	468	481	511	541	569	
	Y115 085 77	Posture back	fully adj w/pivot	587	600	631	660	689	
	Y135 085 77	back	vertical adj arms	544	555	587	617	644	
	Y145 085 77		fully adj/no pivot	574	587	619	648	676	
	Y105 091 77	Low Back	no arms	490	504	535	563	593	
	Y115 091 77	posture mech.	fully adj w/pivot	611	624	655	684	713	
	Y135 091 77		vertical adj arms	568	580	611	641	668	
	Y145 091 77		fully adj/no pivot	599	612	644	673	701	
	Y105 095 77	Low Back,	no arms	412	424	457	484	513	
	Y115 095 77	swivel tilt mech	fully adj w/pivot pads	531	545	576	605	634	
	Y135 095 77		vertical adj only	487	502	531	561	589	
	Y145 095 77		fully adjustable	520	531	565	592	621	
	Y105 099 77	Low Back,	no arms	365	376	408	438	464	
	Y115 099 77	non-tilt mech	fully adj w/pivot pads	484	496	528	557	584	
	Y135 099 77	(back in/out only)	vertical adj only	445	458	490	518	548	
	Y145 099 77		fully adjustable	471	484	515	546	572	
	Y127 142 77	Guest with glides	fixed arms	407	419	450	479	507	
	Y127 14C 77	Guest with casters	fixed arms	419	431	461	491	519	
	Z103 215 77	Stool Mid Back syncro mech	no arms	664	676	708	737	764	
	Z105 215 77	Stool Low Back syncro mech	no arms	648	660	692	721	749	
	Y100 FAA 77	Pair of Arms	fully adj w/pivot pads	121					
	Y100 VAA 77	Pair of Arms	vertical adj only	75					
	Y100 FAN 77	Pair of Arms	fully adjustable	108					

FOR SOFT DUAL WHEEL CASTERS ADD "K" TO MODEL NUMBER EXAMPLE Y101 051 77K AND ADD \$28 TO LIST PRICE ABOVE.

FOR UPHOLSTERED OUTER BACKS ADD SUFFIX LETTER "U" TO MODEL NUMBER,

EXAMPLE: Y103 054 77U AND ADD LIST PRICE UPCHARGE AS NOTED BELOW:

HIGH BACKS ADD: GRADE I GRADE II GRADE III GRADE IV GRADE V

 62 71 87 104 123

MID & LOW BACKS GRADE I GRADE II GRADE III GRADE IV GRADE V

 47 58 73 91 109

NOTE: SOME FABRICS MAY NOT BE SUITABLE FOR UPHOLSTERED OUTER BACKS. TO INSURE QUALITY, ALL FABRICS ARE SUBJECT TO APPROVAL WHEN USED IN THIS APPLICATION.

QS Ships in 2 days in selected fabrics. See 2-Day QuickShip Brochure.

Numbers below indicate mechanism and base associated per chair series.

Mechanisms

099 Basic task control, swivels, gas cylinder, horizontal back adjustment • 095 Swivel tilt control, adjustable tension

051 Synchro control adjusts seat and back at 2 to 1 ratio with single lever

054 Asynchronous control adjusts seat and back with separate levers with seat slider

Finishes Available: • Black - 77

See page 10 for mechanism information.

Grade-In Prices and Availability						Approximate Overall Size			Seat		Ht. From Floor		Approx. Weight, Pack & Cube Ydg. Req.
Grade A	Grade B	Grade C	Grade D	Grade E	Grade F	W	D	H	W	D	Seat	Arm	
617	627	639	649	660	671	25		36.8			21.5	--	28
737	748	759	769	781	791		25	to	20.5	18	to	28.5	32
692	702	714	724	735	746	26.5		33			17.8	to	1 PK KD
724	734	746	756	767	778							24.8	10.3 cu - 1¼ yds
642	652	663	674	685	695	25		36.8			21.5	--	28
761	771	783	793	804	815		25	to	20.5	18	to	28.5	32
717	727	739	749	760	770	26.5		33			17.8	to	1 PK KD
750	760	771	782	793	803							24.8	10.3 cu - 1¼ yds
561	572	583	593	605	615	25		36.75			21.5	--	28
683	693	705	715	726	736		25	to	20.5	18	to	28.5	32
638	648	659	670	681	691	26.5		33			17.75	to	1 PK KD
670	680	691	701	713	723							24.75	10.3 cu - 1¼ yds
512	522	534	544	555	565	25		36.75			21.5	--	28
632	643	654	664	676	686		25	to	20.5	18	to	28.5	32
596	607	618	628	640	650	26.5		33			17.75	to	1 PK KD
620	630	642	652	663	674							24.75	10.3 cu - 1¼ yds
562	576	588	600	613	626	23	26.25	37.5	20	17	19	25.5	25
													1 PK SU
													10.8 - 1¾ yds
575	588	600	613	625	639	23	26.25	37.5	20	17	19	25.5	25
													1 PK SU
													10.8 - 1¾ yds
813	823	834	845	856	866	25	25	54.5 to 44.5	20.5	18	32.5 to 26.5	--	42
													1 PK SU
													16.7 cu - 1¼ yds
797	808	819	829	840	851	25	25	50 to 40	20.5	18	32.5 to 26.5	--	40
													1 PK SU
													16.7 cu - 1¼ yds



EDGE

• Two back height designs • Arm options: vertical adjustment only; fully adjustable. • Multiple mechanisms ranging from basic task to asynchronous with seat slider. • Heavy duty 55mm casters are standard • Class 4 gas cylinder provides weight capacity in excess of 400 pounds • Molded contoured Ultrafoam "modified tractor" seat design standard • Molded contoured Ultrafoam back for sleek ergonomic fit • Ratchet mechanism back height adjustment for ergonomic fit from a seated position

Illustration	Item Number	Description	Arms	Price and Upholstery Availability						
				Grade I	COM Grade II	Grade III	Grade IV	Grade V	Grade LM	
	Y203 E51 77	Mid Back	No arms	588	600	631	662	690		
	Y213 E51 77	syncro mech	w/fully adj arms	701	713	744	775	803		
	Y233 E51 77		vertical adj arms	668	680	711	741	771		
	Y203 E54 77	Mid Back	No arms	626	637	669	700	727		
	Y213 E54 77	Asyncro mech	w/fully adj arms	735	748	779	809	836		
	Y233 E54 77	w/seat slider	vertical adj arms	702	715	746	776	804		
	Y203 E91 77	Mid Back	No arms	612	626	656	687	715		
	Y213 E91 77	posture mech.	w/fully adj arms	722	735	765	797	824		
	Y233 E91 77		vertical adj arms	689	702	734	763	792		
	Y203 E95 77	Mid Back	No arms	513	525	558	587	615		
	Y213 E95 77	swivel tilt mech.	w/fully adj arms	624	635	667	698	726		
	Y233 E95 77		vertical adj arms	590	603	634	665	692		
	Y205 E51 77	Low Back	No arms	571	583	614	645	673		
	Y215 E51 77	syncro mech	w/fully adj arms	680	692	725	755	782		
	Y235 E51 77		vertical adj arms	647	660	691	722	751		
	Y205 E54 77	Low Back	No arms	604	615	647	678	706		
	Y215 E54 77	Asyncro mech	w/fully adj arms	713	726	757	788	816		
	Y235 E54 77	w/seat slider	vertical adj arms	680	692	725	755	782		
	Y205 E91 77	Low Back	No arms	588	600	631	662	690		
	Y215 E91 77	posture mech.	w/fully adj arms	701	713	744	775	803		
	Y235 E91 77		vertical adj arms	668	680	711	741	771		
	Y205 E95 77	Low Back	No arms	490	503	534	565	593		
	Y215 E95 77	swivel tilt mech.	w/fully adj arms	604	616	649	678	707		
	Y235 E95 77		vertical adj arms	571	584	615	647	674		
		Y227 142 77	Guest with glides	fixed arms	415	427	457	488	517	
		Y227 14C 77	Guest with casters	fixed arms	427	439	470	501	525	
		Z205 E15 77	Low Back adjustable ht.	No arms	672	685	713	742	770	
Z215 E15 77		Stool	w/fully adj arms	784	797	825	855	882		

For soft dual wheel casters add suffix letter "K" to model number example: Y101 051 77K and add \$28 to list price above.
QS Ships in 2 days in selected fabrics. See 2-Day QuickShip Brochure.

Numbers below indicate mechanism and base associated per chair series.

Mechanisms: (E95) is a swivel tilt mechanism with tension adjustment. • (E51) mechanism is a tension adjustable synchro-mechanism that allows the user to adjust the seat and back with one lever. • (E54) mechanism is an asynchronous mechanism that is tension adjustable with separate adjustment levers for the seat and back angle and also includes a seat slider which has 2 1/2" of travel. • (E91) The "Revo" mechanism is a side tension posture back mechanism with a 2.5 to 1 seat to back ratio. The unique side tension adjustment located on the right side side makes personal adjustment an easy task.

Finishes Available: • **Black - 77**

See page 10 for mechanism information.

Grade-In Prices and Availability						Approximate Overall Size			Seat		Ht. From Floor		Approx. Weight, Pack & Cube Ydg. Req.
Grade A	Grade B	Grade C	Grade D	Grade E	Grade F	W	D	H	W	D	Seat	Arm	
747	760	773	785	798	812			43			21	30.3	28 1 PK KD 10.3 cu - 1 1/4 yds
860	874	886	899	911	925	26.5	23	to	20	18.5	to	to	
827	841	854	866	879	893			37			17.5	23.3	
783	797	810	822	835	848			44			22	31.3	30 1 PK KD 10.3 cu - 1 1/4 yds
893	906	919	931	944	958	26.5	23	to	20	18.5	to	to	
861	875	887	900	912	926			38			18.5	24.3	
772	785	798	811	823	837			44			22	31.3	32 1 PK KD 10.3 cu - 1 1/4 yds
881	895	907	920	932	946	26.5	23	to	20	18.5	to	to	
848	862	875	887	900	914			38			18.5	24.3	
644	654	666	676	688	698			43.5			21.5	30.8	28 1 PK KD 10.3 cu - 1 1/4 yds
754	764	776	786	798	809	26.5	23	to	20	18.5	to	to	
720	731	742	753	764	775			37.5			18	23.8	
722	733	744	755	767	777			39			21	30.3	28 1 PK KD 10.3 cu - 1 1/2 yds
832	842	854	864	876	886	26.5	23	to	20	18.5	to	to	
800	811	822	833	844	855			33			17.5	23.3	
755	765	777	788	799	810			39.5			22	31.3	30 1 PK KD 10.3 cu - 1 1/2 yds
865	876	887	898	909	920	26.5	23	to	20	18.5	to	to	
832	842	854	864	876	886			33.5			18.5	24.3	
739	750	761	772	783	794			39.5			22	31.3	32 1 PK KD 10.3 cu - 1 1/2 yds
853	863	875	885	897	907	26.5	23	to	20	18.5	to	to	
820	831	842	853	864	875			33.5			18.5	24.3	
622	632	644	654	666	676			39			21.5	30.3	28 1 PK KD 10.3 cu - 1 1/2 yds
735	746	757	768	779	790	26.5	23	to	20	18.5	to	to	
702	713	725	735	747	757			33			18	23.3	
566	576	588	599	610	621			37.5					25 1 PK SU 10.8 cu - 1 1/4 yds
						23	26.5		20	17	19	25.5	
574	585	596	607	618	629								
819	830	841	852	863	874			54			32	38.5	40 1 PK SU 16.7 cu
						26.5	27.5	to	20	18.5	to	to	
931	942	953	964	975	986			43.5			24.5	31	



ZYN

• ZYN achieves the correct balance in design, material selection and comfort. • The ergonomically shaped back and seat combined with the dual back post and variety of options and finishes make ZYN the right chair for any project. • ZYN multi-use seating line has applications ranging from conference, training, executive, management, task and guest versions to enhance any office environment. • ZYN is available in three metal finishes – chrome, black and nickel. • There are two bases – chrome or black steel or nylon (black only). • Both fixed and adjustable arms are available for various uses including task, executive or conferencing. • Mechanisms are available in three options synchro-tilt, synchro-tilt with seat slide and a swivel-tilt. • ZYN has a unique wrap-around back and is available in both high and mid back height versions. • The executive chair's adjustable headrest offers height, depth and pivot action to position it for just about anyone. • ZYN's guest chair has a playful one-of-a-kind motion back for a natural seating experience. • The guest chair frame is available in any of the three finishes of ebony, nickel or chrome.

SEATING Chairs, Metal

Illustration	Item Number	Base	Description	Arms	Price and Upholstery Availability					
					Grade I	COM Grade II	Grade III	Grade IV	Grade V	Grade LM
	Y300 180 77	Black	High Back with headrest swivel/tilt mech lock/unlock	no arms fully adj/ non pivot cap fixed	535	556	584	613	644	773
	Y340 180 77	molded plastic		665	692	727	763	802	962	
	Y360 180 77	plastic		637	663	696	731	768	922	
	Y300 280 01	Chrome		580	603	633	665	698	838	
	Y300 280 21	Nickel paint		570	593	623	655	688	826	
	Y300 280 77	Black paint		570	593	623	655	688	826	
	Y340 280 01	Chrome		699	733	780	808	848	1,016	
	Y340 280 21	Nickel paint		695	723	759	797	837	1,004	
	Y340 280 77	Black paint		695	723	759	797	837	1,004	
	Y360 280 01	Chrome		685	712	748	785	825	990	
	Y360 280 21	Nickel paint		665	692	727	763	802	962	
	Y360 280 77	Black paint		665	692	727	763	802	962	
	Y300 181 77	Black	High Back with headrest synchro mech	no arms fully adj/ non pivot cap fixed	598	622	653	685	719	863
	Y340 181 77	molded plastic		729	758	796	836	878	1,054	
	Y360 181 77	plastic		699	727	763	802	842	1,010	
	Y300 281 01	Chrome		646	669	703	739	775	928	
	Y300 281 21	Nickel paint		636	661	694	729	765	918	
	Y300 281 77	Black paint		636	661	694	729	765	918	
	Y340 281 01	Chrome		765	795	834	904	949	1,138	
	Y340 281 21	Nickel paint		755	785	824	865	908	1,090	
	Y340 281 77	Black paint		755	785	824	865	908	1,090	
	Y360 281 01	Chrome		745	774	813	854	897	1,076	
	Y360 281 21	Nickel paint		725	754	792	832	874	1,049	
	Y360 281 77	Black paint		725	754	792	832	874	1,049	
	Y300 184 77	Black	High Back with headrest synchro mech with seat-slider	no arms fully adj/ non pivot cap fixed	629	654	687	721	757	809
	Y340 184 77	molded plastic		766	797	837	879	923	1,108	
	Y360 184 77	plastic		733	763	802	842	884	1,061	
	Y300 284 01	Chrome		679	706	739	776	815	978	
	Y300 284 21	Nickel paint		669	696	729	765	804	965	
	Y300 284 77	Black paint		669	696	729	765	804	965	
	Y340 284 01	Chrome		799	837	879	923	970	1,165	
	Y340 284 21	Nickel paint		795	827	869	913	959	1,151	
	Y340 284 77	Black paint		795	827	869	913	959	1,151	
	Y360 284 01	Chrome		780	811	852	895	940	1,128	
	Y360 284 21	Nickel paint		760	791	831	873	917	1,100	
	Y360 284 77	Black paint		760	791	831	873	917	1,100	

Numbers below indicate mechanism and base associated per chair series.

Mechanisms

- 180/280 Swivel tilt control, adjustable tension
- 181/281 Synchro control adjusts seat and back at 2 to 1 ratio with single lever
- 184/284 Synchro control adjusts seat and back with single lever with seat slider

Finishes Available: • Chrome - 01 • Black - 77 • Nickel - 21

Grade-In Prices and Availability							Approximate Overall Size			Seat		Ht. From Floor		Approx. Weight, Pack & Cube Ydg. Req.
Grade A	Grade B	Grade C	Grade D	Grade E	Grade F	W	D	H	W	D	Seat	Arm		
714	730	745	761	777	793			48 1/2"			17 1/2"	-	49 lbs.	
872	888	903	919	935	951	26"	26"	to	21"	18"	to	23 7/8" to 32 3/4"	1 PK SU	
838	854	869	885	901	917			51 1/2"			20"	25 1/4" to 28"	18.2 cu - 2 yds	
768	784	799	815	831	847			48 1/2"			17 1/2"	-	49 lbs.	
758	774	789	805	821	837	26"	26"	to	21"	18"	to	-	1 PK SU	
758	774	789	805	821	837			51 1/2"			20"	-	18.2 cu - 2 yds	
918	934	949	965	981	997			48 1/2"			17 1/2"	-	49 lbs.	
907	923	938	954	970	986	26"	26"	to	21"	18"	to	23 7/8" to 32 3/4"	1 PK SU	
907	923	938	954	970	986			51 1/2"			20"	-	18.2 cu - 2 yds	
895	911	926	942	958	974			48 1/2"			17 1/2"	-	49 lbs.	
872	888	903	919	935	951	26"	26"	to	21"	18"	to	25 1/4" to 28"	1 PK SU	
872	888	903	919	935	951			51 1/2"			20"	-	18.2 cu - 2 yds	
789	805	820	836	852	868			48 1/2"			17 1/2"	-	50 lbs.	
948	964	979	995	1,011	1,027	26"	26"	to	21"	18"	to	23 7/8" to 32 3/4"	1 PK SU	
912	928	943	959	975	991			51 1/2"			20"	-	18.2 cu - 2 yds	
845	861	876	892	908	924			48 1/2"			17 1/2"	-	50 lbs.	
835	851	866	882	898	914	26"	26"	to	21"	18"	to	-	1 PK SU	
835	851	866	882	898	914			51 1/2"			20"	-	18.2 cu - 2 yds	
1,019	1,035	1,050	1,066	1,082	1,098			48 1/2"			17 1/2"	-	50 lbs.	
978	994	1,009	1,025	1,041	1,057	26"	26"	to	21"	18"	to	23 7/8" to 32 3/4"	1 PK SU	
978	994	1,009	1,025	1,041	1,057			51 1/2"			20"	-	18.2 cu - 2 yds	
967	983	998	1,014	1,030	1,046			48 1/2"			17 1/2"	-	50 lbs.	
944	960	975	991	1,007	1,023	26"	26"	to	21"	18"	to	25 1/4" to 28"	1 PK SU	
944	960	975	991	1,007	1,023			51 1/2"			20"	-	18.2 cu - 2 yds	
827	843	858	874	890	906			49 1/2"			18 1/2"	-	53 lbs.	
993	1,009	1,024	1,040	1,056	1,072	26"	26"	to	21"	18"	to	24 7/8" to 31 3/4"	1 PK SU	
954	970	985	1,001	1,017	1,033			52 1/2"			21"	26 1/4" to 29"	18.2 cu - 2 yds	
885	901	916	932	948	964			49 1/2"			18 1/2"	-	53 lbs.	
874	890	905	921	937	953	26"	26"	to	21"	18"	to	-	1 PK SU	
874	890	905	921	937	953			52 1/2"			21"	-	18.2 cu - 2 yds	
1,040	1,056	1,071	1,087	1,103	1,119			49 1/2"			18 1/2"	-	53 lbs.	
1,029	1,045	1,060	1,076	1,092	1,108	26"	26"	to	21"	18"	to	24 7/8" to 31 3/4"	1 PK SU	
1,029	1,045	1,060	1,076	1,092	1,108			52 1/2"			21"	-	18.2 cu - 2 yds	
1,010	1,026	1,041	1,057	1,073	1,089			49 1/2"			18 1/2"	-	53 lbs.	
987	1,003	1,018	1,034	1,050	1,066	26"	26"	to	21"	18"	to	26 1/4" to 29"	1 PK SU	
987	1,003	1,018	1,034	1,050	1,066			52 1/2"			21"	-	18.2 cu - 2 yds	

Continued on next page...



ZYN

• ZYN achieves the correct balance in design, material selection and comfort. • The ergonomically shaped back and seat combined with the dual back post and variety of options and finishes make ZYN the right chair for any project. • ZYN multi-use seating line has applications ranging from conference, training, executive, management, task and guest versions to enhance any office environment. • ZYN is available in three metal finishes – chrome, black and nickel. • There are two bases – chrome or black steel or nylon (black only). • Both fixed and adjustable arms are available for various uses including task, executive or conferencing. • Mechanisms are available in three options synchro-tilt, synchro-tilt with seat slide and a swivel-tilt. • ZYN has a unique wrap-around back and is available in both high and mid back height versions. • The executive chair's adjustable headrest offers height, depth and pivot action to position it for just about anyone. • ZYN's guest chair has a playful one-of-a kind motion back for a natural seating experience. • The guest chair frame is available in any of the three finishes of ebony, nickel or chrome.

SEATING Chairs, Metal

Illustration	Item Number	Base	Description	Arms	Price and Upholstery Availability					
					Grade I	COM Grade II	Grade III	Grade IV	Grade V	Grade LM
	Y301 180 77	Black	High Back No headrest swivel/tilt mech lock/unlock	no arms fully adj/ non pivot cap	426	444	466	489	514	617
	Y341 180 77	molded plastic		fixed	552	575	604	634	666	799
	Y361 180 77	plastic		fixed	527	548	575	604	634	761
	Y301 280 01	Chrome		no arms	470	489	514	539	566	679
	Y301 280 21	Nickel paint		no arms	460	479	503	528	555	666
	Y301 280 77	Black paint		no arms	460	479	503	528	555	666
	Y341 280 01	Chrome		fully adj / non pivot cap	590	614	644	676	709	850
	Y341 280 21	Nickel paint		fully adj / non pivot cap	580	604	634	666	699	839
	Y341 280 77	Black paint		fully adj / non pivot cap	580	604	634	666	699	839
	Y361 280 01	Chrome		fixed	575	598	628	659	692	830
	Y361 280 21	Nickel paint		fixed	555	578	610	641	673	808
	Y361 280 77	Black paint		fixed	555	578	610	641	673	808
	Y301 181 77	Black	High Back No headrest synchro mech	no arms fully adj/ non pivot cap	489	509	534	561	589	707
	Y341 181 77	molded plastic		fixed	617	642	674	708	743	892
	Y361 181 77	plastic		fixed	590	614	645	678	712	855
	Y301 281 01	Chrome		no arms	535	556	583	612	642	770
	Y301 281 21	Nickel paint		no arms	525	546	573	602	632	759
	Y301 281 77	Black paint		no arms	525	546	573	602	632	759
	Y341 281 01	Chrome		fully adj / non pivot cap	654	680	713	748	785	942
	Y341 281 21	Nickel paint		fully adj / non pivot cap	644	670	703	738	775	930
	Y341 281 77	Black paint		fully adj / non pivot cap	644	670	703	738	775	930
	Y361 281 01	Chrome		fixed	632	658	691	726	762	914
	Y361 281 21	Nickel paint		fixed	618	643	675	709	745	895
	Y361 281 77	Black paint		fixed	618	643	675	709	745	895
	Y301 184 77	Black	High Back No headrest synchro mech with seat-slider	no arms fully adj/ non pivot cap	523	544	572	599	629	755
	Y341 184 77	molded plastic		fixed	652	679	713	748	785	942
	Y361 184 77	plastic		fixed	624	647	679	713	749	899
	Y301 284 01	Chrome		no arms	570	593	622	653	684	821
	Y301 284 21	Nickel paint		no arms	560	583	612	642	674	809
	Y301 284 77	Black paint		no arms	560	583	612	642	674	809
	Y341 284 01	Chrome		fully adj / non pivot cap	689	716	751	788	828	994
	Y341 284 21	Nickel paint		fully adj / non pivot cap	679	706	741	778	817	980
	Y341 284 77	Black paint		fully adj / non pivot cap	679	706	741	778	817	980
	Y361 284 01	Chrome		fixed	672	699	734	771	810	972
	Y361 284 21	Nickel paint		fixed	650	676	709	745	782	939
	Y361 284 77	Black paint		fixed	650	676	709	745	782	939

Numbers below indicate mechanism and base associated per chair series.

Mechanisms

- 180/280 Swivel tilt control, adjustable tension
- 181/281 Synchro control adjusts seat and back at 2 to 1 ratio with single lever
- 184/284 Synchro control adjusts seat and back with single lever with seat slider

Finishes Available: • Chrome - 01 • Black - 77 • Nickel - 21

Grade-In Prices and Availability							Approximate Overall Size			Seat		Ht. From Floor		Approx. Weight, Pack & Cube Ydg. Req.
Grade A	Grade B	Grade C	Grade D	Grade E	Grade F	W	D	H	W	D	Seat	Arm		
584	600	615	631	647	663			38½"			17½"	-	48 lbs.	
736	752	767	783	799	815	26"	26"	to	21"	18"	to	23⅞" to 32¾"	1 PK SU	
704	720	735	751	767	783			41½"			20"	25¼" to 28"	18.2 cu - 2 yds	
636	652	667	683	699	715			38½"			17½"	-	48 lbs.	
625	641	656	672	688	704	26"	26"	to	21"	18"	to	-	1 PK SU	
625	641	656	672	688	704			41½"			20"	-	15.5 cu - 2 yds	
779	795	810	826	842	858			38½"			17½"	-	48 lbs.	
769	785	800	816	832	848	26"	26"	to	21"	18"	to	23⅞" to 32¾"	1 PK SU	
769	785	800	816	832	848			41½"			20"	-	15.5 cu - 2 yds	
762	778	793	809	825	841			38½"			17½"	-	48 lbs.	
743	759	774	790	806	822	26"	26"	to	21"	18"	to	25¼" to 28"	1 PK SU	
743	759	774	790	806	822			41½"			20"	-	15.5 cu - 2 yds	
659	675	690	706	722	738			38½"			17½"	-	47 lbs.	
813	829	844	860	876	892	26"	26"	to	21"	18"	to	23⅞" to 32¾"	1 PK SU	
782	798	813	829	845	861			41½"			20"	25¼" to 28"	15.5 cu - 1.75 yds	
712	728	743	759	775	791			38½"			17½"	-	48 lbs.	
702	718	733	749	765	781	26"	26"	to	21"	18"	to	-	1 PK SU	
702	718	733	749	765	781			41½"			20"	-	15.5 cu - 1.75 yds	
855	871	886	902	918	934			38½"			17½"	-	48 lbs.	
845	861	876	892	908	924	26"	26"	to	21"	18"	to	23⅞" to 32¾"	1 PK SU	
845	861	876	892	908	924			41½"			20"	-	15.5 cu - 1.75 yds	
832	848	863	879	895	911			38½"			17½"	-	48 lbs.	
815	831	846	862	878	894	26"	26"	to	21"	18"	to	25¼" to 28"	1 PK SU	
815	831	846	862	878	894			41½"			20"	-	15.5 cu - 1.75 yds	
699	715	730	746	762	778			38½"			18½"	-	50 lbs.	
855	871	886	902	918	934	26"	26"	to	21"	18"	to	24⅞" to 31¾"	1 PK SU	
819	835	850	866	882	898			41½"			21"	26¼" to 29"	15.5 cu - 1.75 yds	
754	770	785	801	817	833			38½"			18½"	-	50 lbs.	
744	760	775	791	807	823	26"	26"	to	21"	18"	to	-	1 PK SU	
744	760	775	791	807	823			41½"			21"	-	15.5 cu - 1.75 yds	
898	914	929	945	961	977			38½"			18½"	-	50 lbs.	
887	903	918	934	950	966	26"	26"	to	21"	18"	to	24⅞" to 31¾"	1 PK SU	
887	903	918	934	950	966			41½"			21"	-	15.5 cu - 1.75 yds	
880	896	911	927	943	959			38½"			18½"	-	50 lbs.	
852	868	883	899	915	931	26"	26"	to	21"	18"	to	26¼" to 29"	1 PK SU	
852	868	883	899	915	931			41½"			21"	-	15.5 cu - 1.75 yds	

Continued on next page...



ZYN

• ZYN achieves the correct balance in design, material selection and comfort. • The ergonomically shaped back and seat combined with the dual back post and variety of options and finishes make ZYN the right chair for any project. • ZYN multi-use seating line has applications ranging from conference, training, executive, management, task and guest versions to enhance any office environment. • ZYN is available in three metal finishes – chrome, black and nickel. • There are two bases – chrome or black steel or nylon (black only). • Both fixed and adjustable arms are available for various uses including task, executive or conferencing. • Mechanisms are available in three options synchro-tilt, synchro-tilt with seat slide and a swivel-tilt. • ZYN has a unique wrap-around back and is available in both high and mid back height versions. • The executive chair's adjustable headrest offers height, depth and pivot action to position it for just about anyone. • ZYN's guest chair has a playful one-of-a-kind motion back for a natural seating experience. • The guest chair frame is available in any of the three finishes of ebony, nickel or chrome.

SEATING Chairs, Metal

Illustration	Item Number	Base	Description	Arms	Price and Upholstery Availability					
					Grade I	COM Grade II	Grade III	Grade IV	Grade V	Grade LM
	Y303 180 77	Black	Mid Back No headrest swivel/tilt mech lock/unlock	no arms fully adj/ non pivot cap	376	391	411	432	456	548
	Y343 180 77	molded plastic		fixed	515	536	563	592	625	750
	Y363 180 77	plastic		fixed	492	512	538	565	593	712
	Y303 280 01	Chrome		fully adj / non pivot cap	421	436	458	481	505	606
	Y303 280 21	Nickel paint		fully adj / non pivot cap	411	428	449	472	496	595
	Y303 280 77	Black paint		fully adj / non pivot cap	411	428	449	472	496	595
	Y343 280 01	Chrome		fixed	552	574	602	632	663	796
	Y343 280 21	Nickel paint		fixed	542	564	592	622	653	784
	Y343 280 77	Black paint		fixed	542	564	592	622	653	784
	Y363 280 01	Chrome		fixed	540	562	590	619	650	780
	Y363 280 21	Nickel paint		fixed	529	550	578	607	638	766
	Y363 280 77	Black paint		fixed	529	550	578	607	638	766
	Y303 181 77	Black	Mid Back No headrest synchro mech	no arms fully adj/ non pivot cap	439	458	481	505	530	636
	Y343 181 77	molded plastic		fixed	580	604	635	667	699	839
	Y363 181 77	plastic		fixed	555	578	607	637	669	803
	Y303 281 01	Chrome		fully adj / non pivot cap	485	504	529	555	582	698
	Y303 281 21	Nickel paint		fully adj / non pivot cap	475	494	519	545	572	686
	Y303 281 77	Black paint		fully adj / non pivot cap	475	494	519	545	572	686
	Y343 281 01	Chrome		fixed	618	642	675	709	743	891
	Y343 281 21	Nickel paint		fixed	608	632	664	697	732	879
	Y343 281 77	Black paint		fixed	608	632	664	697	732	879
	Y363 281 01	Chrome		fixed	596	619	650	683	718	862
	Y363 281 21	Nickel paint		fixed	582	605	635	667	699	839
	Y363 281 77	Black paint		fixed	582	605	635	667	699	839
	Y303 184 77	Black	Mid Back No headrest synchro mech with seat-slider	no arms fully adj/ non pivot cap	473	492	516	542	569	683
	Y343 184 77	molded plastic		fixed	615	639	671	705	740	888
	Y363 184 77	plastic		fixed	589	613	644	676	709	851
	Y303 284 01	Chrome		fully adj / non pivot cap	519	539	566	595	625	750
	Y303 284 21	Nickel paint		fully adj / non pivot cap	509	529	555	583	612	734
	Y303 284 77	Black paint		fully adj / non pivot cap	509	529	555	583	612	734
	Y343 284 01	Chrome		fixed	653	679	712	748	784	941
	Y343 284 21	Nickel paint		fixed	643	669	702	737	774	929
	Y343 284 77	Black paint		fixed	643	669	702	737	774	929
	Y363 284 01	Chrome		fixed	625	650	682	716	752	903
	Y363 284 21	Nickel paint		fixed	618	643	675	709	744	893
	Y363 284 77	Black paint		fixed	618	643	675	709	744	893
	Y367 187 01	Chrome	Guest Chair	fixed arms	457	476	499	524	550	660
	Y367 187 21	Nickel paint			443	459	482	506	532	639
	Y367 187 77	Black paint			443	459	482	506	532	639

Numbers below indicate mechanism and base associated per chair series.

Mechanisms

- 180/280 Swivel tilt control, adjustable tension
- 181/281 Synchro control adjusts seat and back at 2 to 1 ratio with single lever
- 184/284 Synchro control adjusts seat and back with single lever with seat slider

Finishes Available: • Chrome - 01 • Black - 77 • Nickel - 21

Grade-In Prices and Availability							Approximate Overall Size			Seat		Ht. From Floor		Approx. Weight, Pack & Cube Ydg. Req.
Grade A	Grade B	Grade C	Grade D	Grade E	Grade F	W	D	H	W	D	Seat	Arm		
526	542	557	573	589	605			34½"			17½"	-	47 lbs.	
695	711	726	742	758	774	26"	26"	to	21"	18"	to	23⅞" to 32¾"	1 PK SU	
663	679	694	710	726	742			37½"			20"	25¼" to 28"	15.5 cu - 1.5 yds	
575	591	606	622	638	654			34½"			17½"	-	47 lbs.	
566	582	597	613	629	645	26"	26"	to	21"	18"	to	-	1 PK SU	
566	582	597	613	629	645			37½"			20"	-	15.5 cu - 1.5 yds	
733	749	764	780	796	812			34½"			17½"	-	47 lbs.	
723	739	754	770	786	802	26"	26"	to	21"	18"	to	23⅞" to 32¾"	1 PK SU	
723	739	754	770	786	802			37½"			20"	-	15.5 cu - 1.5 yds	
720	736	751	767	783	799			34½"			17½"	-	47 lbs.	
708	724	739	755	771	787	26"	26"	to	21"	18"	to	25¼" to 28"	1 PK SU	
708	724	739	755	771	787			37½"			20"	-	15.5 cu - 1.5 yds	
600	616	631	647	663	679			34½"			17½"	-	48 lbs.	
769	785	800	816	832	848	26"	26"	to	21"	18"	to	23⅞" to 32¾"	1 PK SU	
739	755	770	786	802	818			37½"			20"	25¼" to 28"	15.5 cu - 1.5 yds	
652	668	683	699	715	731			34½"			17½"	-	48 lbs.	
642	658	673	689	705	721	26"	26"	to	21"	18"	to	-	1 PK SU	
642	658	673	689	705	721			37½"			20"	-	15.5 cu - 1.5 yds	
813	829	844	860	876	892			34½"			17½"	-	48 lbs.	
802	818	833	849	865	881	26"	26"	to	21"	18"	to	23⅞" to 32¾"	1 PK SU	
802	818	833	849	865	881			37½"			20"	-	15.5 cu - 1.5 yds	
788	804	819	835	851	867			34½"			17½"	-	48 lbs.	
769	785	800	816	832	848	26"	26"	to	21"	18"	to	25¼" to 28"	1 PK SU	
769	785	800	816	832	848			37½"			20"	-	15.5 cu - 1.5 yds	
639	655	670	686	702	718			34½"			18½"	-	49 lbs.	
810	826	841	857	873	889	26"	26"	to	21"	18"	to	24⅞" to 31¾"	1 PK SU	
779	795	810	826	842	858			38½"			21"	26¼" to 29"	15.5 cu - 1.5 yds	
695	711	726	742	758	774			34½"			18½"	-	49 lbs.	
682	698	713	729	745	761	26"	26"	to	21"	18"	to	-	1 PK SU	
682	698	713	729	745	761			38½"			21"	-	15.5 cu - 1.5 yds	
854	870	885	901	917	933			34½"			18½"	-	49 lbs.	
844	860	875	891	907	923	26"	26"	to	21"	18"	to	24⅞" to 31¾"	1 PK SU	
844	860	875	891	907	923			38½"			21"	-	15.5 cu - 1.5 yds	
822	838	853	869	885	901			34½"			18½"	-	49 lbs.	
814	830	845	861	877	893	26"	26"	to	21"	18"	to	26¼" to 29"	1 PK SU	
814	830	845	861	877	893			38½"			21"	-	15.5 cu - 1.5 yds	
620	636	651	667	683	699								45 lbs.	
602	618	633	649	665	681	25½"	27"	36½"	21"	18"	17½"	25½"	1 PK SU	
602	618	633	649	665	681								15.5 cu - 1.5 yds	



EPIX

- Uniquely shaped urethane over steel arms with connection points underneath the seat and on the outside of the back
- Tapered tuxedo back gives EPIX a sleek, clean appearance
- Thin overall profile adds to the elegance of EPIX
- Uniquely tailored head rest adds character and functionality
- Built in lumbar and waterfall seat promotes comfort and reduces fatigue
- Knee tilt mechanism with multi-position lockout feature
- Locking swivel tilt mechanism provides comfort at an affordable price
- High profile poly resin base
- Guest chair frame of one inch (1") diameter by thirteen gauge steel tubing with all welded joints
- Eleven ply high density multi-contoured plywood seat
- Seven ply high density multi-contoured plywood back
- 55 MM heavy duty casters are standard on all caster version chairs
- Heavy duty Class IV gas cylinder is standard equipment

SEATING Chairs, Metal

Illustration	Item Number	Description	Price and Upholstery Availability					
			Grade I	COM Grade II	Grade III	Grade IV	Grade V	Grade LM
	X241 150 77	Executive Chair Tilt Lock	599	624	657	708	758	934
	X241 450 77	Executive Chair Tilt Lock Knee-Tilt	660	672	705	756	806	982
	X242 150 77	Executive Chair Tilt Lock Adjustable Arms	599	624	657	708	758	934
	X242 450 77	Executive Chair Tilt Lock, Knee-tilt Adjustable Arms	660	672	705	756	806	982
	X243 150 77	Management Chair Tilt Lock	560	582	615	668	712	840
	X243 450 77	Management Chair Tilt Lock Knee-Tilt	619	630	663	716	760	887
	X244 150 77	Management Chair Tilt Lock Adjustable Arms	560	582	615	668	712	840
	X244 450 77	Management Chair Tilt Lock, Knee-tilt Adjustable Arms	619	630	663	716	760	887
	X247 128 77	Guest Chair Sled Frame	550	561	594	647	691	818

PATTERNS NOT AVAILABLE ON THIS SERIES: REGAL

For soft dual wheel casters add suffix letter "K" to model number – example: Y101 051 77K and add \$28 to list price above.

Finishes Available: • Black - 77

See page 10 for mechanism information.

Grade-In Prices and Availability						Approximate Overall Size			Seat		Ht. From Floor		Approx. Weight, Pack & Cube Ydg. Req.
Grade A	Grade B	Grade C	Grade D	Grade E	Grade F	W	D	H	W	D	Seat	Arm	
841	859	878	896	915	933	25½	24	46¾ to 43½	20½	19	21¼ to 18	30 to 26¾	47 lbs. 1 PK KD 15.7 CU - 2½ yds
888	906	925	943	962	981	25½	24	48¼ to 44½	20½	19	22¾ to 19	31½ to 27¾	51 lbs. 1 PK KD 15.7 CU - 2½ yds
841	859	878	896	915	933	26	24	46¾ to 43½	20½	19	21¼ to 18	33 to 25¾	47 lbs. 1 PK KD 15.7 CU - 2½ yds
888	906	925	943	962	981	26	24	48¼ to 44½	20½	19	22¾ to 19	33½ to 26¾	51 lbs. 1 PK KD 15.7 CU - 2½ yds
787	803	819	836	853	870	25½	24	41 to 37¾	20½	19	21¼ to 18	30 to 26¾	44 lbs. 1 PK KD 11.7 CU - 2¼ yds
834	851	867	884	901	918	25½	24	42½ to 38¾	20½	19	22¾ to 19	31½ to 27¾	48 lbs. 1 PK KD 11.7 CU - 2¼ yds
787	803	819	836	853	870	26	24	41 to 31¾	20½	19	21¼ to 18	33 to 25¾	44 lbs. 1 PK KD 11.7 CU - 2¼ yds
834	851	867	884	901	918	26	24	42½ to 38¾	20½	19	22¾ to 19	33½ to 26¾	48 lbs. 1 PK KD 11.7 CU - 2¼ yds
765	782	798	815	832	849	22½	27	37½	20½	19	18½	26¾	45 lbs. 1 PK SU 14.7 CU - 2¼ yds



ICON

- Sculptured tooled aluminum back bar
- Uniquely shaped urethane over steel arms
- Tapered tuxedo back
- Ergonomic shaped waterfall seat
- Inner seat, 1" soft fiberfill material over 2" of high resilient foam
- Seven ply high density multi-contoured plywood seat and back
- Metal to metal connectors
- Guest chair frame of 1 1/4" dia. 16 gauge and 1" 14 gauge steel tubing with welded joints
- Arm brackets and back bar of polished 380 Alloy Aluminum
- High profile aluminum or plastic base
- Knee tilt mechanism with multi-position lock
- Heavy duty Class IV gas cylinder and 55 mm casters standard

SEATING Chairs, Metal

Illustration	Item Number	Finish	Finish	Price and Upholstery Availability					
				Grade I	COM Grade II	Grade III	Grade IV	Grade V	Grade LM
	X321 840 02	Pol Alum	Exec. Chair with arms knee tilt	880	916	972	1,031	1,089	1,294
	X321 850 77	Black		836	872	928	987	1,045	1,238
	X322 840 02	Pol Alum	Exec. Chair knee tilt adjustable arms	880	916	972	1,031	1,089	1,294
	X322 850 77	Black		836	872	928	987	1,045	1,238
	X323 840 02	Pol Alum	Mgmt. Chair with arms knee tilt	770	802	858	912	968	1,155
	X323 850 77	Black		730	763	818	874	928	1,100
	X324 840 02	Pol Alum	Mgmt. Chair knee tilt adjustable arms	770	802	858	912	968	1,155
	X324 850 77	Black		730	763	818	874	928	1,100
	X327 847 01	Chrome	Guest arms with glides	700	733	789	843	899	1,086
	X327 847 77	Black		660	693	749	803	859	1,031
	X327 84C 01	Chrome	Guest arms with casters	707	740	795	851	905	1,093
	X327 84C 77	Black		670	704	758	814	868	1,041
	X327 848 01	Chrome	Guest fixed arms SLED frame	700	733	789	843	899	1,086
	X327 848 77	Black		660	693	749	803	859	1,031
	X329 847 01	Chrome	Guest adjustable arms 4 leg, glides	700	733	789	843	899	1,086
	X329 847 77	Black		660	693	749	803	859	1,031
	X329 84C 01	Chrome	Guest adjustable arms 4 leg, casters	707	740	795	851	905	1,093
	X329 84C 77	Black		670	704	758	814	868	1,041
	X329 848 01	Chrome	Guest adjustable arms SLED frame	700	733	789	843	899	1,086
	X329 848 77	Black		660	693	749	803	859	1,031

QS Ships in 2 days in selected fabrics. See 2-Day QuickShip Brochure.

Finishes Available: • Chrome - 01 • Polished Alum. - 02
 • Black - 77
Arms: BLACK ONLY

See page 10 for
 mechanism information.

Grade-In Prices and Availability							Approximate Overall Size			Seat		Ht. From Floor		Approx. Weight, Pack & Cube Ydg. Req.
Grade A	Grade B	Grade C	Grade D	Grade E	Grade F	W	D	H	W	D	Seat	Arm		
1,195	1,219	1,242	1,266	1,290	1,315	24.5	25.5	47.5	20.5	19	22.75	30.25	58 1 PK KD 15.7 cu - 3¼ yds	
1,151	1,175	1,198	1,222	1,246	1,271			to 43.75			to 19	26.5		
1,195	1,219	1,242	1,266	1,290	1,315	26	25.5	47.5	20.5	19	22.75	32.25	57 1 PK KD 15.7 cu - 3¼ yds	
1,151	1,175	1,198	1,222	1,246	1,271			to 43.75			to 19	25.5		
1,064	1,088	1,110	1,132	1,154	1,176	24.5	25.5	40.25	20.5	19	22.75	30.25	54 1 PK KD 11.7 cu - 3 yds	
1,024	1,048	1,070	1,092	1,114	1,136			to 36.5			to 19	26.5		
1,064	1,088	1,110	1,132	1,154	1,176	26	25.5	40.25	20.5	19	22.75	32.25	53 1 PK KD 15.5 cu - 3 yds	
1,024	1,048	1,070	1,092	1,114	1,136			to 36.5			to 19	25.5		
994	1,019	1,041	1,063	1,085	1,107	24.5	26	36.5	20.5	19	19	26.5	43 1 PK SU 15.5 cu - 3 yds	
954	979	1,001	1,023	1,045	1,067									
1,001	1,025	1,047	1,069	1,091	1,113	24.5	26	36.5	20.5	19	19	26.5	43 1 PK SU 15.5 cu - 3 yds	
964	988	1,010	1,032	1,054	1,076									
994	1,019	1,041	1,063	1,085	1,107	24.5	26	36.5	20.5	19	19	26.5	47 1 PK SU 15.5 cu - 3 yds	
954	979	1,001	1,023	1,045	1,067									
994	1,019	1,041	1,063	1,085	1,107	26	26	36.5	20.5	19	19	28.5	42 1 PK SU 15.5 cu - 3 yds	
954	979	1,001	1,023	1,045	1,067							to 25.5		
1,001	1,025	1,047	1,069	1,091	1,113	26	26	36.5	20.5	19	19	28.5	42 1 PK SU 15.5 cu - 3 yds	
964	988	1,010	1,032	1,054	1,076							to 25.5		
994	1,019	1,041	1,063	1,085	1,107	26	26	36.5	20.5	19	19	28.5	46 1 PK SU 15.5 cu - 3 yds	
954	979	1,001	1,023	1,045	1,067							to 25.5		



ICON Ultra

• ICON Ultra upholstery technique exaggerates thick-to-thin tapers throughout the back and arm gives the product a sense of motion visually. • Integrated headrest with contemporary angular shape • 55 MM heavy duty casters, and heavy duty class IV gas cylinder are standard • Sculptured tooled aluminum back part is both aesthetic and functional. • Uniquely shaped urethane over steel arms with angled connection points • Tapered tuxedo back gives ICON a tailored classic look • Ergonomic shape and waterfall seat promotes comfort and reduces fatigue • Seven ply high density multi-contoured plywood seat and back • Metal to metal connectors throughout • Guest chair frame of 1 1/4" diameter by sixteen gauge and 1" by fourteen gauge steel tubing with all welded joints. • Arm brackets and back bar of polished 380 Alloy Aluminum • High profile aluminum and plastic version base • Knee tilt mechanism with multi-position lockout feature • Reverse hour-glass shape provides unique visual appeal

SEATING Chairs, Metal

Illustration	Item Number	Finish	Finish	Price and Upholstery Availability					
				Grade I	COM Grade II	Grade III	Grade IV	Grade V	Grade LM
	X331 840 02	Pol Alum	Exec. Chair knee tilt with arms	832	845	880	933	985	1170
	X331 850 77	Black		788	800	835	888	940	1126
	X332 840 02	Pol Alum	Exec. Chair knee tilt adjustable arms	832	845	880	933	985	1170
	X332 850 77	Black		788	800	835	888	940	1126
	X333 840 02	Pol Alum	Mgmt. Chair knee tilt with arms	721	732	766	823	869	1003
	X333 850 77	Black		682	692	727	782	829	962
	X334 840 02	Pol Alum	Mgmt. Chair knee tilt adjustable arms	721	732	766	823	869	1003
	X334 850 77	Black		682	692	727	782	829	962
	X337 847 01	Chrome	Guest arms with glides	651	663	696	750	797	931
	X337 847 77	Black		611	622	657	710	757	890
	X339 847 01	Chrome	Guest adjustable arms 4 leg, glides	651	663	696	750	797	931
	X339 847 77	Black		611	622	657	710	757	890
	X337 84C 01	Chrome	Guest arms with casters	658	669	704	757	803	937
	X337 84C 77	Black		621	632	667	720	766	900
	X339 84C 01	Chrome	Guest adjustable arms 4 leg, casters	658	669	704	757	803	937
	X339 84C 77	Black		621	632	667	720	766	900
	X337 848 01	Chrome	Guest fixed arms SLED frame	651	663	696	750	797	931
	X337 848 77	Black		611	622	657	710	757	890
	X339 848 01	Chrome	Guest adjustable arms SLED frame	651	663	696	750	797	931
	X339 848 77	Black		611	622	657	710	757	890

Finishes Available: • Chrome - 01 • Polished Alum. - 02
 • Black - 77
Arms: BLACK ONLY

See page 10 for
 mechanism information.

Grade-In Prices and Availability							Approximate Overall Size			Seat		Ht. From Floor		Approx. Weight, Pack & Cube Ydg. Req.
Grade A	Grade B	Grade C	Grade D	Grade E	Grade F	W	D	H	W	D	Seat	Arm		
1,067	1,085	1,105	1,123	1,142	1,160	24.5	25	47.5	20.5	19	21.5	30.25	56 1 PK KD 15.7 cu - 2.5 yds	
1,023	1,041	1,060	1,078	1,097	1,115			to 43.75			to 17.75	26.5		
1,067	1,085	1,105	1,123	1,142	1,160	26	25	47.5	20.5	19	21.5	32.25	55 1 PK KD 15.7 cu - 2.5 yds	
1,023	1,041	1,060	1,078	1,097	1,115			to 43.75			to 17.75	25.5		
935	950	965	979	994	1,009	24.5	25	40.25	20.5	19	21.5	30.25	52 1 PK KD 11.7 cu - 2 yds	
895	909	924	939	954	969			to 36.5			to 17.75	26.5		
935	950	965	979	994	1,009	26	25	40.25	20.5	19	21.5	32.25	51 1 PK KD 11.7 cu - 2 yds	
895	909	924	939	954	969			to 36.5			to 17.75	25.5		
863	878	893	907	922	937	24.5	25.5	36.5	20.5	19	17.75	26.5	42 1 PK SU 15.5 cu - 2 yds	
823	837	852	867	882	897									
863	878	893	907	922	937	26	25.5	36.5	20.5	19	17.75	28.5	42 1 PK SU 15.5 cu - 2 yds	
823	837	852	867	882	897						to 17.75	to 25.5		
869	884	899	914	929	943	24.5	25.5	36.5	20.5	19	17.75	26.5	42 1 PK SU 15.5 cu - 2 yds	
832	847	862	877	891	906									
869	884	899	914	929	943	26	25.5	36.5	20.5	19	17.75	28.5	42 1 PK SU 15.5 cu - 2 yds	
832	847	862	877	891	906						to 17.75	to 25.5		
863	878	893	907	922	937	24.5	25.5	36.5	20.5	19	17.5	26.5	46 1 PK SU 15.5 cu - 2 yds	
823	837	852	867	882	897									
863	878	893	907	922	937	26	25.5	36.5	20.5	19	17.5	28.5	46 1 PK SU 15.5 cu - 2 yds	
823	837	852	867	882	897						to 17.5	to 25.5		



QUEST

- Ergonomic design featuring contoured seat and back.
- Executive and management seating feature lumbar support.
- Waterfall seat front for comfortable upper-thigh support.
- 5-star base with 2" dual wheel casters for general purpose.
- Features swivel tilt and knee tilt mechanism both with tilt lock.
- Sculptured urethane over steel arm for strength.
- Heavy duty Class IV gas cylinder and 55 mm casters standard

SEATING Chairs, Metal

Illustration	Item Number	Description	Price and Upholstery Availability					
			Grade I	COM Grade II	Grade III	Grade IV	Grade V	Grade LM
QS	X461 120 77	Executive Chair	575	587	622	677	730	919
QS	X461 130 77	Exec. Chair Knee-Tilt	626	642	675	734	787	975
QS	X463 120 77	Management Chair	561	569	604	661	709	846
QS	X463 130 77	Mgmt. Chair Knee-Tilt	613	624	661	716	764	901
QS	X467 041 77	Guest Chair	452	489	545	604	660	755

PATTERNS NOT AVAILABLE ON THIS SERIES: REGAL.

For soft dual wheel casters add suffix letter "K" to model number – example: Y101 051 77K and add \$28 to list price above.

QS Ships in 2 days in selected fabrics. See 2-Day QuickShip Brochure.

JURY CHAIR

	X465 JRY 77	Management Seat & Back JURY BASE–NOT FREE STANDING	743	753	790	846	891	1,031
--	--------------------	---	------------	------------	------------	------------	------------	--------------

NOT FREESTANDING—MUST ATTACH TO FLOOR.



TRIA

- Seat and back is one piece, 9 ply hardwood shell
- Back foam cushioning is molded in place with lumbar support
- Arms are self skin urethane over steel
- Base is molded-in glass reinforced co-polymer
- Heavy duty Class IV gas cylinder and 55 mm casters standard

Illustration	Item Number	Description	Price and Upholstery Availability					
			Grade I	COM Grade II	Grade III	Grade IV	Grade V	Grade LM
	X481 170 77	Exec. Chair • Tilt Lock Arms	820	841	878	916	948	1,275
	X483 170 77	Mgmt. Chair • Tilt Lock Arms	782	801	841	878	913	1,200
	X484 170 77	Mgmt. Chair • Tilt Lock Armless	707	728	764	801	836	1,126
	X487 329 77	Sled Base • Guest Chair Arms	598	615	642	663	688	931
	X488 329 77	Sled Base • Guest Chair Arms	522	542	566	589	610	856

PATTERNS NOT AVAILABLE ON THIS SERIES: REGAL

For soft dual wheel casters add suffix letter "K" to model number example: Y101 051 77K and add \$28 to list price above.

Numbers below indicate mechanism and base associated per chair series.

Mechanisms

120 Mid pivot swivel tilt with upright lock feature.

130 Knee tilt control with upright lock feature

Finishes Available: • Black - 77

See page 10 for mechanism information.

Grade-In Prices and Availability						Approximate Overall Size			Seat		Ht. From Floor		Approx. Weight, Pack & Cube Ydg. Req.
Grade A	Grade B	Grade C	Grade D	Grade E	Grade F	W	D	H	W	D	Seat	Arm	
813	831	850	868	887	905	26	26 ³ / ₄	45	21	19	22	30	44 lbs. 1 CTN KD 12.7 CU - 2 ¹ / ₂ yds
869	887	906	924	943	961			to			18	26	
792	810	829	847	866	884	26	26 ¹ / ₂	42	21	19	22	30	41 lbs. 1 CTN KD 11.4 CU - 2 ¹ / ₄ yds
847	865	884	902	921	939			to			18	26	
743	761	780	798	817	835	23	26	35 ¹ / ₂	19 ³ / ₄	19	18 ¹ / ₂	25 ³ / ₄	38 lbs. 1 CTN SU 14.3 CU - 1 ³ / ₄ yds

974	992	1,011	1,029	1,048	1,066	26	26 ¹ / ₂	39	21	19	18	25	43 lbs. 1 CTN KD 11.4 CU - 2 ¹ / ₄ yds
-----	-----	-------	-------	-------	-------	----	--------------------------------	----	----	----	----	----	---

Numbers below indicate mechanism and base associated per chair series.

Mechanisms

170 Mid pivot swivel tilt control with upright lock feature

Finishes Available: • Black - 77

See page 10 for mechanism information.

Grade-In Prices and Availability						Approximate Overall Size			Seat		Ht. From Floor		Approx. Weight, Pack & Cube Ydg. Req.
Grade A	Grade B	Grade C	Grade D	Grade E	Grade F	W	D	H	W	D	Seat	Arm	
1,030	1,048	1,067	1,085	1,105	1,123	26	26 ¹ / ₂	46 ¹ / ₄ to 42 ³ / ₄	20 ³ / ₄	18 ³ / ₄	21 ¹ / ₂ to 18	28 ¹ / ₂ to 25	55 lbs. 1 Pk KD 15.7 CU - 2 ¹ / ₂ yds
995	1,013	1,032	1,050	1,070	1,088			26			25 ¹ / ₂	41 ¹ / ₂ to 38	20 ³ / ₄
919	937	956	974	993	1,011	26	25 ¹ / ₂	41 ¹ / ₂ to 38	20 ³ / ₄	18 ³ / ₄	21 ¹ / ₂ to 18	—	42 lbs. 1 Pk KD 10.3 CU - 2 ¹ / ₄ yds
771	789	808	826	845	863	26	25 ¹ / ₂	40	20 ³ / ₄	18 ³ / ₄	18	25	48 lbs. 1 Pk SU 18.5 CU - 2 ¹ / ₄ yds
692	710	729	747	766	784	26	25 ¹ / ₂	40	20 ³ / ₄	18 ³ / ₄	18	—	42 lbs. 1 Pk SU 18.5 CU - 2 ¹ / ₄ yds



SOLAS

• Urethane arm pads are constructed over a structural steel frame. • Extra soft seat and back are ergonomically contoured for proper support and comfort. • One-piece 9 ply hardwood plywood outer shell. • Loose upholstery technique adds to the soft and supple appearance. • Available in chrome or black paint version. • "P" roll-over cushion at the top of each back. • Knee-tilt mechanism with lock feature. • Heavy duty Class IV gas cylinder and 55 mm casters standard

Illustration	Item Number	Description	Price and Upholstery Availability					
			Grade I	COM Grade II	Grade III	Grade IV	Grade V	Grade LM
 QS	X381 116 01	Executive Chair	906	941	986	1,044	1,101	1,324
	X381 136 77		802	836	880	939	974	1,154
	X381 770 01		956	990	1,035	1,093	1,151	1,373
	X381 780 77		852	885	929	988	1,024	1,203
 QS	X382 116 01	Executive Chair with adjustable arms	906	941	986	1,044	1,101	1,324
	X382 136 77		802	836	880	939	974	1,154
	X382 770 01		956	990	1,035	1,093	1,151	1,373
	X382 780 77		852	885	929	988	1,024	1,203
 QS	X383 116 01	Management Chair	853	886	932	989	1,047	1,244
	X383 136 77		747	782	827	882	920	1,075
	X383 770 01		902	936	982	1,038	1,096	1,294
	X383 780 77		796	832	877	931	969	1,125
 QS	X384 116 01	Management Chair with adjustable arms	853	886	932	989	1,047	1,244
	X384 136 77		747	782	827	882	920	1,075
	X384 770 01		902	936	982	1,038	1,096	1,294
	X384 780 77		796	832	877	931	969	1,125
 QS	X387 147 01	Guest Chair	747	780	815	849	883	1,020
	X387 147 77		695	728	763	796	832	968

For soft dual wheel casters add suffix letter "K" to model number — example: Y101 051 77K and add \$28 to list price above.

JURY CHAIR

	X385 JRY 77	Management Seat & Back	968	1,002	1,045	1,101	1,162	1,318
		JURY BASE – NOT FREE STANDING						

NOT FREESTANDING—MUST ATTACH TO FLOOR. PATTERNS NOT AVAILABLE ON THIS SERIES: REGAL.



ARC

• Molded, contoured seat and back foam
 • Pronounced lumbar support
 • Waterfall seat front for comfortable under-thigh support
 • Heavy duty Class IV gas cylinder and 55 mm casters standard

Illustration	Item Number	Description	Price and Upholstery Availability					
			Grade I	COM Grade II	Grade III	Grade IV	Grade V	Grade LM
 QS	X731 120 77	Executive Chair	620	639	664	701	734	920
	X731 190 77	Executive Chair Knee-Tilt	709	729	754	791	824	1,010
 QS	X733 120 77	Management Chair	587	606	635	668	703	887
	X733 190 77	Management Chair Knee-Tilt	672	690	719	752	788	972
 QS	X737 329 77	Guest Chair	550	568	600	624	655	850

PATTERNS NOT AVAILABLE ON THIS SERIES: REGAL

For soft dual wheel casters add suffix letter "K" to model number — example: Y101 051 77K and add \$28 to list price above.

QS Ships in 2 days in selected fabrics. See 2-Day QuickShip Brochure.

Numbers below indicate mechanism and base associated per chair series.

Mechanisms

770/780 Knee tilt control with upright lock feature

JRY Jury base with return mechanism, floor mounted, requires installation

Finishes Available: • Chrome - 01 • Black - 77

See page 10 for mechanism information.

Grade-In Prices and Availability						Approximate Overall Size			Seat		Ht. From Floor		Approx. Weight, Pack & Cube Ydg. Req.
Grade A	Grade B	Grade C	Grade D	Grade E	Grade F	W	D	H	W	D	Seat	Arm	
1,223	1,252	1,279	1,306	1,334	1,362	26	27	46¼ to 42	21	19	22¼ to 18	31 to 26¾	60 lbs. 1 CTN KD 12.7 CU - 3¾ yds
1,096	1,125	1,152	1,179	1,206	1,235								
1,273	1,301	1,328	1,356	1,383	1,411								
1,146	1,174	1,201	1,229	1,256	1,284								
1,223	1,252	1,279	1,306	1,334	1,362	27½	27	46¼ to 42	21	19	22¼ to 18	29¼ to 25	60 lbs. 1 CTN KD 12.7 CU - 3¾ yds
1,096	1,125	1,152	1,179	1,206	1,235								
1,273	1,301	1,328	1,356	1,383	1,411								
1,146	1,174	1,201	1,229	1,256	1,284								
1,169	1,197	1,224	1,252	1,279	1,307	26	26	42¼ to 38	21	19	22¼ to 18	31 to 26¾	57 lbs. 1 CTN KD 11.2 CU - 3½ yds
1,042	1,070	1,097	1,125	1,152	1,180								
1,218	1,246	1,274	1,301	1,328	1,357								
1,091	1,119	1,147	1,174	1,201	1,230								
1,169	1,197	1,224	1,252	1,279	1,307	27½	26	42¼ to 38	21	19	22¼ to 18	29¼ to 25	57 lbs. 1 CTN KD 11.2 CU - 3½ yds
1,042	1,070	1,097	1,125	1,152	1,180								
1,218	1,246	1,274	1,301	1,328	1,357								
1,091	1,119	1,147	1,174	1,201	1,230								
1,005	1,033	1,061	1,088	1,115	1,143	22¾	28	36	20	19	18½	26¼	25 lbs. 1 CTN SU 15.0 CU - 3 yds
927	951	973	995	1,017	1,040								

1,284	1,313	1,340	1,367	1,394	1,423	26	26	39	21	19	18	26	59 lbs. 1 CTN KD 11.2 CU - 3½ yds
-------	-------	-------	-------	-------	-------	----	----	----	----	----	----	----	--------------------------------------

Numbers below indicate mechanism and base associated per chair series.

Mechanisms

190 Knee tilt control with upright lock feature

Finishes Available: • Black - 77

See page 10 for mechanism information.

Grade-In Prices and Availability						Approximate Overall Size			Seat		Ht. From Floor		Approx. Weight, Pack & Cube Ydg. Req.
Grade A	Grade B	Grade C	Grade D	Grade E	Grade F	W	D	H	W	D	Seat	Arm	
809	826	842	859	876	893	27½	28	45½ to 42	19½	19	21½ to 18	29½ to 26	35 lbs. 1 Pk KD 12.4 CU - 2¼ yds
899	916	932	949	966	983								
778	795	811	828	845	862	27½	27½	39½ to 36	19½	19	21½ to 18	29½ to 26	26 lbs. 1 Pk KD 12.1 CU - 2 yds
862	880	896	913	930	947								
730	747	763	780	797	814	24	30	35½	19½	19	18	26	48 lbs. 1 Pk SU 18.5 CU - 2 yds



DIVA

• Diva is available in six frame finishes and eight stunning plastic shell colors for a variety of combinations to suit any décor. • Diva's generous plastic seat and back wrap you in ergonomic comfort. If that is not enough....just add upholstered seat and back pads for a custom appearance and fit beyond compare. • Diva's perforated plastic back enhances air flow for a more comfortable seating experience. • The back also incorporates a built in lumbar for proper seating posture and increased comfort. • Diva's ergonomically contoured seat has an innovative opening in the seat pan. The opening doubles as a hand hold for stacking purposes and aids in the event of spills or when used for occasional outdoor use. • Diva's glides are dual purpose since they protect the floor and serve as a ganging device. • All Diva glides are made of a non-marring polycarbonate material for years of trouble free service. • Each chair comes complete with four glides the glides on the right side seated are grooved to accept a tab from the glides located on the left

SEATING Chairs, Metal

Illustration	Item Number	Finish	Shell Color	Description	Price and Upholstery Availability					
					No Uph.	Grade I	Grade II	Grade III	Grade IV	Grade V
	X980 217 01A	Chrome	Putty	Molded	135	—	—	—	—	—
	X980 217 01D		Maroon							
	X980 217 01E		Ebony	Seat/Back						
	X980 217 01G		Grey							
	X980 217 01N		Navy	Armless						
	X980 217 01R		Primary Red							
	X980 217 01U		Bright Blue							
	X980 217 01W		Chartreuse							
X980 217 01W	Green									
	X980 217 __ A	See top of page paint legend	Putty	Molded	135	—	—	—	—	—
	X980 217 __ D		Maroon							
	X980 217 __ E		Ebony	Seat/Back						
	X980 217 __ G		Grey							
	X980 217 __ N		Navy	Armless						
	X980 217 __ R		Primary Red							
	X980 217 __ U		Bright Blue							
	X980 217 __ W		Chartreuse							
X980 217 __ W	Green									

Illustration	Item Number	Finish	Shell Color	Description	Price and Upholstery Availability					
					Grade I	Grade II	Grade III	Grade IV	Grade V	Leather Match
	X982 217 01A	Chrome	Putty	Molded	234	246	259	272	286	345
	X982 217 01D		Maroon							
	X982 217 01E		Ebony	Seat/Back With Upholstered						
	X982 217 01G		Grey							
	X982 217 01N		Navy	Seat/Back Pads						
	X982 217 01R		Primary Red							
	X982 217 01U		Bright Blue							
	X982 217 01W		Chartreuse							
X982 217 01W	Green									
	X982 217 __ A	See top of page paint legend	Putty	Molded	234	246	259	272	286	345
	X982 217 __ D		Maroon							
	X982 217 __ E		Ebony	Seat/Back With Upholstered						
	X982 217 __ G		Grey							
	X982 217 __ N		Navy	Seat/Back Pads						
	X982 217 __ R		Primary Red							
	X982 217 __ U		Bright Blue							
	X982 217 __ W		Chartreuse							
X982 217 __ W	Green									

EXAMPLE:

X980 217

2 digits indicate paint finish:
 77 Black
 85 Med. Grey
 21 Nickel
 98 Pewter
 45 Taupe

Finishes Available: • Chrome - 01 • Black - 77 • Med. Grey - 85
 • Nickel - 21 • Pewter - 98 • Taupe - 45

Shell Color: • Putty – A • Maroon – D • Ebony – E • Grey – G • Navy – N
 • Primary Red – R • Bright Blue – U • Chartreuse Green - M

Grade-In Prices and Availability						Approximate Overall Size			Seat		Ht. From Floor		Approx. Weight, Pack & Cube Ydg. Req.
Grade A	Grade B	Grade C	Grade D	Grade E	Grade F	W	D	H	W	D	Seat	Arm	
													1 PK SU 21 lbs. 10.7 CU
						18	22	31½	18	17	18¾	—	2 PK SU 34 lbs. 11.9 CU
													4 PK SU 60 lbs. 15 CU

Grade-In Prices and Availability						Approximate Overall Size			Seat		Ht. From Floor		Approx. Weight, Pack & Cube Ydg. Req.
Grade A	Grade B	Grade C	Grade D	Grade E	Grade F	W	D	H	W	D	Seat	Arm	
317	324	331	338	345	349								1 PK SU 23 lbs. 10.7 CU .75 yds.
						18	22	31½	18	17	18¾	—	2 PK SU 36 lbs. 11.9 CU .75 yds.
317	324	331	338	345	349								4 PK SU 62 lbs. 15 CU .75 yds.

Continued on next page...



DIVA

• Diva is available in six frame finishes and eight stunning plastic shell colors for a variety of combinations to suit any décor. • Diva's generous plastic seat and back wrap you in ergonomic comfort. If that is not enough....just add upholstered seat and back pads for a custom appearance and fit beyond compare. • Diva's perforated plastic back enhances air flow for a more comfortable seating experience. • The back also incorporates a built in lumbar for proper seating posture and increased comfort. • Diva's ergonomically contoured seat has an innovative opening in the seat pan. The opening doubles as a hand hold for stacking purposes and aids in the event of spills or when used for occasional outdoor use. • Diva's glides are dual purpose since they protect the floor and serve as a ganging device. • All Diva glides are made of a non-marring polycarbonate material for years of trouble free service. • Each chair comes complete with four glides the glides on the right side seated are grooved to accept a tab from the glides located on the left

SEATING Chairs, Metal

Illustration	Item Number	Finish	Shell Color	Description	Price and Upholstery Availability					
					Grade I	Grade II	Grade III	Grade IV	Grade V	Leather Match
	X984 217 01A	Chrome	Putty	Molded Back With Upholstered Seat Pad	194	204	215	226	238	288
	X984 217 01D		Maroon							
	X984 217 01E		Ebony							
	X984 217 01G		Grey							
	X984 217 01N		Navy							
	X984 217 01R		Primary Red							
	X984 217 01U		Bright Blue							
	X984 217 01W		Chartreuse Green							
	X984 217 __ A	See top of page paint legend	Putty	Molded Back With Upholstered Seat Pad	194	204	215	226	238	288
	X984 217 __ D		Maroon							
	X984 217 __ E		Ebony							
	X984 217 __ G		Grey							
	X984 217 __ N		Navy							
	X984 217 __ R		Primary Red							
	X984 217 __ U		Bright Blue							
	X984 217 __ W		Chartreuse Green							
	A032-01	Chrome	Stack Chair Dolly 4 Wheel (Foor X980, X982, X984)	388	—	—	—	—	—	

Finishes Available: • Chrome - 01 • Black - 77 • Med. Grey - 85
 • Nickel - 21 • Pewter - 98 • Taupe - 45

Shell Color: • Putty – A • Maroon – D • Ebony – E • Grey – G • Navy – N
 • Primary Red – R • Bright Blue – U • Chartreuse Green - M

Grade-In Prices and Availability						Approximate Overall Size			Seat		Ht. From Floor		Approx. Weight, Pack & Cube Ydg. Req.
Grade A	Grade B	Grade C	Grade D	Grade E	Grade F	W	D	H	W	D	Seat	Arm	
254	257	261	264	268	272								1 PK SU 22 lbs. 10.7 CU .5 yds.
						18	22	31½	18	17	18¾	—	2 PK SU 35 lbs. 11.9 CU .5 yds.
254	257	261	264	268	272								4 PK SU 61 lbs. 15 CU .5 yds.
													1 PK 20 lbs. 9.7 CU



VISTA

- Frame is welded construction of cold drawn steel rod
- Seat attachment is brackets welded to frame
- Tablet arm adjustment device allows 2 1/2" of adjustment space front to back. Tablet lifts for easy entry and exit. One chair accommodates more individuals.

EXAMPLE:

X902 126 __ E

2 digits indicate paint finish:

- 77 Black
- 85 Med. Grey
- 21 Nickel
- 98 Pewter
- 45 Taupe

SEATING Chairs, Metal

Illustration	Item Number	Frame Finish	Shell Color	Description	Price no upholstery	
QS 	X902 126 01C	Chrome	Cardinal	Molded Seat/Back with Arms (No ganging attachment)	149	
	X902 126 01E		Ebony			
	X902 126 01N		Navy			
	X902 126 01T		Taupe			
	X902 126 __ C		Black 77			Cardinal
	X902 126 __ E		Med Grey 85			Ebony
	X902 126 __ N		Nickel 21			Navy
	X902 126 __ T		Pewter 98			Taupe
	X902 126 __ T		Taupe 45			Taupe
QS 	X905 135 01C	Chrome	Cardinal	Molded Seat/Back No Arms (with ganging attachment)	132	
	X905 135 01E		Ebony			
	X905 135 01N		Navy			
	X905 135 01T		Taupe			
	X905 135 __ C		Black 77			Cardinal
	X905 135 __ E		Med Grey 85			Ebony
	X905 135 __ N		Nickel 21			Navy
	X905 135 __ T		Pewter 98			Taupe
	X905 135 __ T		Taupe 45			Taupe
	A035-01	Chrome		Stack Chair 4-Wheel Dolly (For X902, X905, Chairs)	418	
	AT05R 01	Chrome		VISTA tablet arm kit Right hand (sitting)	145	
	AT05R __			Chromcraft standard laminates	134	
	AT06L 01	Chrome		VISTA tablet arm kit Left hand (sitting)	145	
	AT06L __			Chromcraft standard laminates	134	
QS 	Z905 530 01C	Chrome	Cardinal	Stool Molded Seat/Back Armless	226	
	Z905 530 01E		Ebony			
	Z905 530 01N		Navy			
	Z905 530 01T		Taupe			
	Z905 530 __ C		Black 77			Cardinal
	Z905 530 __ E		Med Grey 85			Ebony
	Z905 530 __ N		Nickel 21			Navy
	Z905 530 __ T		Pewter 98			Taupe
Z905 530 __ T	Taupe 45	Taupe				

VISTA STACKS 40 ON THE DOLLY.

QS Ships in 2 days in chrome ONLY. See 2-Day QuickShip Brochure.

Finishes Available: • Chrome - 01 • Black - 77 • Med. Grey - 85

Arms: Black ONLY • Nickel - 21 • Pewter - 98 • Taupe - 45

Shell Color: • Cardinal - C • Ebony - E • Navy - N • Taupe - T

Grade-In Prices and Availability						Approximate Overall Size			Seat		Ht. From Floor		Approx. Weight, Pack & Cube Ydg. Req.
Grade A	Grade B	Grade C	Grade D	Grade E	Grade F	W	D	H	W	D	Seat	Arm	
		N/A				24½	24½	32	18½	19	17½	24½	39 lbs. 2 Pk SU 12.9 CU
		N/A				21½	24½	32	18½	19	17½	—	34 lbs. 2 Pk SU 11.9 CU
		N/A											20 lbs. 1 Pk SU 9.7 CU
						12¾	23	17					9 lbs. 1 Pk KD 0.8 CU
		N/A				12¾	23	17					9 lbs. 1 Pk KD 0.8 CU
						19¾	25¾	44¾	18½	19	29½	—	28 lbs. 1 Pk SU 15 CU



SYNTAX

• Seat & back are high density polyurethane foam with fire retardant chemicals added • Inner seat & back are formed plywood • Frames are welded 1" steel tubing • Floor level glides are standard • Arms are molded nylon • Tablet arm adjustment device allows 2 1/2" of adjustment space front to back. Tablet lifts for easy entry and exit. One chair accommodates more individuals.

EXAMPLE:

X919 402

2 digits indicate paint finish:

77 Black 98 Pewter

85 Med. Grey 45 Taupe

21 Nickel

Stacking Chair

Illustration	Item Number	Description	Price and Upholstery Availability					
			Grade I	COM Grade II	Grade III	Grade IV	Grade V	Grade LM
	X919 402 01	Stacking Chair	284	293	315	335	350	—
	X919 402 __	Armless	273	283	304	323	337	—
	X920 401 01	Stacking Chair	308	319	340	360	375	—
	X920 401 __	Arms	296	308	329	349	360	—

ABOVE CHAIR 2 PACK CAN SHIP UPS WHEN REQUESTED. SYNTAX STACKS 9 HIGH.

Tablet Arm Chair – Tablet is standard in our Black laminate

Illustration	Item Number	Description	Price and Upholstery Availability					
			Grade I	COM Grade II	Grade III	Grade IV	Grade V	Grade LM
	X917 403 01	Right	413	425	446	466	481	—
	X917 403 __	Tablet	400	409	428	449	462	—
	X918 503 01	Left	413	425	446	466	481	—
	X918 503 __	Tablet	400	409	428	449	462	—
	X917 ISO 01	Right oversize Tablet	427	439	460	480	495	—
	X917 ISO __	width 16 7/8" depth 12"	413	425	446	466	481	—
	X918 ISO 01	Left oversize Tablet	427	439	460	480	495	—
	X918 ISO __	width 16 7/8" depth 12"	413	425	446	466	481	—

Syntax Plus

Illustration	Item Number	Description Syntax with thicker foam	Price and Upholstery Availability					
			Grade I	COM Grade II	Grade III	Grade IV	Grade V	Grade LM
	Y919 402 01	Stacking Chair	297	306	329	349	361	—
	Y919 402 __	Armless	286	296	317	337	350	—
	Y920 401 01	Stacking Chair	320	333	354	375	388	—
	Y920 401 __	with Arms	311	320	340	360	375	—
	YU19 402 01	Stacking Chair	331	339	359	382	395	—
	YU19 402 __	upholstered outer back Armless	319	330	350	370	384	—
	YU20 401 01	Stacking Chair	354	366	387	407	421	—
	YU20 401 __	upholstered outer back with Arms	341	354	374	394	407	—

Syntax – Dolly and Ganging Attachments

Illustration	Item Number	Description	Price
	A075 01	Stack Chair Dolly	407
	A019 77	Ganging Attachment for X919 Stack Chair (Armless) and X929 Sled Chair (Armless)	19
	A020 01	Ganging Attachment for X920 Stack Chair (Arms) and X930 Sled Chair (Arms)	30

QS Ships in 2 days in selected fabrics.

See 2-Day QuickShip Brochure.

Finishes Available: • Chrome - 01 • Black - 77 • Med. Grey - 85
Arms: Black ONLY • Nickel - 21 • Pewter - 98 • Taupe - 45

Grade-In Prices and Availability						Approximate Overall Size			Seat		Ht. From Floor		Approx. Weight, Pack & Cube Ydg. Req.
Grade A	Grade B	Grade C	Grade D	Grade E	Grade F	W	D	H	W	D	Seat	Arm	
368	375	383	390	398	405	20	21	31	18¼	17¾	18	—	79 lbs. 4 Pk SU
356	364	371	378	386	393								14.1 CU - 1 yd
393	401	408	416	423	430	23¾	21	31	18¼	17¾	18	24½	87 lbs. 4 Pk SU
382	389	396	404	411	419								14.1 CU - 1 yd

Grade-In Prices and Availability						Approximate Overall Size			Seat		Ht. From Floor		Approx. Weight, Pack & Cube Ydg. Req.
Grade A	Grade B	Grade C	Grade D	Grade E	Grade F	W	D	H	W	D	Seat	Arm	
499	507	514	522	529	536	22½	28½	32	18¼	17¾	18	27	30 lbs. 1 Pk SU
482	490	497	505	512	519								14.2 CU - 1 yd
499	507	514	522	529	536	22½	28½	32	18¼	17¾	18	27	30 lbs. 1 Pk SU
482	490	497	505	512	519								14.2 CU - 1 yd
528	535	543	550	558	565	22½	31 to 28½	32	18¼	17¾	18	27	30 lbs. 1 Pk SU
514	522	529	536	544	551								14.2 CU - 1 yd
528	535	543	550	558	565	22½	31 to 28½	32	18¼	17¾	18	27	30 lbs. 1 Pk SU
514	522	529	536	544	551								14.2 CU - 1 yd

Grade-In Prices and Availability						Approximate Overall Size			Seat		Ht. From Floor		Approx. Weight, Pack & Cube Ydg. Req.
Grade A	Grade B	Grade C	Grade D	Grade E	Grade F	W	D	H	W	D	Seat	Arm	
382	389	396	404	411	419	20	21	31	18¼	17¾	18	—	79 lbs. 4 Pk SU
370	377	385	392	400	407								14.1 CU - 1 yd
408	416	423	430	438	445	23¾	21	31	18¼	17¾	18	24½	87 lbs. 4 Pk SU
393	401	408	416	423	430								14.1 CU - 1 yd
414	422	429	437	444	452	20	21	31	18¼	17¾	18	—	79 lbs. 4 Pk SU
403	410	418	425	432	440								14.1 CU - 1 yd
440	447	455	462	470	477	23	21	31	18¼	17¾	18	25½	87 lbs. 4 Pk SU
427	435	442	449	457	464								14.1 CU - 1 yd

Finishes Available: • Chrome - 01 • Black - 77

Grade-In Prices and Availability						Approximate Overall Size			Seat		Ht. From Floor		Approx. Weight, Pack & Cube Ydg. Req.
Grade A	Grade B	Grade C	Grade D	Grade E	Grade F	W	D	H	W	D	Seat	Arm	
						—	—	—	—	—	—	—	18 lbs. 1 CTN KD 13.2 CU
						—	—	—	—	—	—	—	1 lb. 1 SET per pkg.
						—	—	—	—	—	—	—	1 lb. 1 SET per pkg.



PYRAMID

- Available: arms, armless, left-hand and right-hand only version.
- Unlimited configurations possible.
- Frames: oval tubing with all joints welded for strength and stability.
- Ganging options. • Arm caps textured urethane with metal inner structure.
- Ideal for waiting rooms. • In-line tables available.
- Two back styles: open or closed to accommodate all situations.

EXAMPLE:

X939 502 __

2 digits indicate
paint finish:
77 Black
85 Med. Grey
21 Nickel
98 Pewter
45 Taupe

Chairs

Illustration	Item Number	Description	Price and Upholstery Availability					
			Grade I	COM Grade II	Grade III	Grade IV	Grade V	Grade LM
	X939 501 01	Guest Chair	476	499	517	537	555	—
	X939 501 __	Open Back Armless	448	467	483	504	522	—
	X940 502 01	Guest Chair	523	541	562	581	600	—
	X940 502 __	Open Back Arms	489	508	526	545	563	—
	X941 501 01	Guest Chair	476	499	517	537	555	—
	X941 501 __	Full Back Armless	448	467	483	504	522	—
	X942 502 01	Guest Chair	523	541	562	581	600	—
	X942 502 __	Full Back Arms	489	508	526	545	563	—
	X943 50R 01	Guest Chair • Open Back	500	519	538	558	579	—
	X943 50R __	Right Arm Only (Sitting)	470	487	506	525	542	—
	X944 50L 01	Guest Chair • Open Back	500	519	538	558	579	—
	X944 50L __	Left Arm Only (Sitting)	470	487	506	525	542	—
	X945 50R 01	Guest Chair • Full Back	500	519	538	558	579	—
	X945 50R __	Right Arm Only (Sitting)	470	487	506	525	542	—
	X946 50L 01	Guest Chair • Full Back	500	519	538	558	579	—
	X946 50L __	Left Arm Only (Sitting)	470	487	506	525	542	—

Tables

Illustration	Item Number	Chromcraft's	Table Price
	R942 552 01	24 Standard	346
	R942 552 __	Laminates	279
	RC44 554 01	See Page 108 for complete list.	465
	RC44 554 __		395
	A039 - - - 01	Ganging attachment for Pyramid chairs without arms	140
	A039 - - - __		99
	A040 - - - 01	Ganging attachment for Pyramid chairs with arms	140
	A040 - - - __		99

TABLES ARE NOT FREESTANDING.
INSTALLS BETWEEN PYRAMID CHAIRS.

Finishes Available: • Chrome - 01 • Black - 77 • Med. Grey - 85
Arms: Black ONLY • Nickel - 21 • Pewter - 98 • Taupe - 45

Grade-In Prices and Availability						Approximate Overall Size			Seat		Ht. From Floor		Approx. Weight, Pack & Cube Ydg. Req.
Grade A	Grade B	Grade C	Grade D	Grade E	Grade F	W	D	H	W	D	Seat	Arm	
603	618	633	648	663	677	23	25	34	19 ¹ / ₄	18 ¹ / ₂	18 ¹ / ₂		23 lbs. 1 Pk SU
569	584	599	614	629	643								14.3 CU - 2 yds
647	661	676	691	706	721	26 ³ / ₄	25	34	19 ¹ / ₄	18 ¹ / ₂	18 ¹ / ₂	25	25 lbs. 1 Pk SU
611	625	640	655	670	685								15.38 CU - 2 yds
603	618	633	648	663	677	23	25	34	19 ¹ / ₄	18 ¹ / ₂	18 ¹ / ₂		23 lbs. 1 Pk SU
569	584	599	614	629	643								14.3 CU - 2 yds
647	661	676	691	706	721	26 ³ / ₄	25	34	19 ¹ / ₄	18 ¹ / ₂	18 ¹ / ₂	25	26 lbs. 1 Pk SU
611	625	640	655	670	685								15.38 CU - 2 ¹ / ₂ yds
623	638	653	668	683	697	25	25	34	19 ¹ / ₄	18 ¹ / ₂	18 ¹ / ₂	25	24 lbs. 1 Pk SU
590	605	620	635	650	665								15.38 CU - 2 yds
623	638	653	668	683	697	25	25	34	19 ¹ / ₄	18 ¹ / ₂	18 ¹ / ₂	25	24 lbs. 1 Pk SU
590	605	620	635	650	665								15.38 CU - 2 yds
623	638	653	668	683	697	25	25	34	19 ¹ / ₄	18 ¹ / ₂	18 ¹ / ₂	25	25 lbs. 1 Pk SU
590	605	620	635	650	665								15.38 CU - 2 ¹ / ₂ yds
623	638	653	668	683	697	25	25	34	19 ¹ / ₄	18 ¹ / ₂	18 ¹ / ₂		25 lbs. 1 Pk SU
590	605	620	635	650	665								15.38 CU - 2 ¹ / ₂ yds

Finishes Available: • Chrome - 01 • Black - 77 • Pewter - 98

Grade-In Prices and Availability						Approximate Overall Size			Approx. Weight, Pack & Cube Ydg. Req.
Grade A	Grade B	Grade C	Grade D	Grade E	Grade F	W	D	H	
						18 ³ / ₄	18 ³ / ₄	16 ³ / ₄	18 lbs. 1 Pk KD 2.55 CU
						29 ³ / ₈	29 ³ / ₈	16 ³ / ₄	30 lbs. 1 Pk KD 2.70 CU
						—	—	—	7 lbs. 1 Pk KD 0.148 CU
						—	—	—	7 lbs. 1 Pk KD 0.148 CU



PYRAMID SPECIAL PURPOSE SEATING

- Pyramid Bariatric version chair. • Tested in excess of 1200 pounds
- Full 30" width between the arms • Urethane over steel arms resists contamination and infiltration
- 1/2" marine plywood inner back with 3/16" outer plywood back
- 5/8" 5 ply marine plywood seat • Sturdy all welded frame
- Gang with Pyramid seating or can stand alone.

EXAMPLE:

X947 601 __

2 digits indicate paint finish:
 77 Black
 85 Med. Grey
 21 Nickel
 98 Pewter
 45 Taupe

Chairs

Illustration	Item Number	Description	Price and Upholstery Availability					
			Grade I	COM Grade II	Grade III	Grade IV	Grade V	Grade LM
	X947 601 01	open back armless	752	790	856	919	969	—
	X947 601 __		672	710	774	834	889	—
	X948 602 01	open back with arms	831	868	934	992	1,046	—
	X948 602 __		738	774	842	899	956	—
	X949 601 01	closed back armless	752	790	856	919	969	—
	X949 601 __		672	710	774	834	889	—
	X950 602 01	closed back with arms	831	868	934	992	1,046	—
	X950 602 __		738	774	842	899	956	—

SEATING Chairs, Metal

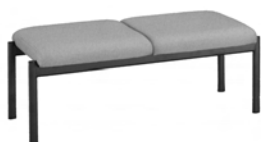

PYRAMID BENCHES

Illustration	Item Number	Description	Price and Upholstery Availability					
			Grade I	COM Grade II	Grade III	Grade IV	Grade V	Grade LM
	A902 642 01	bench 2 seats	544	552	572	593	605	—
	A902 642 __		425	435	455	474	488	—
	A903 643 01	bench 3 seats	712	726	757	784	806	—
	A903 643 __		599	613	643	671	692	—
	A912 643 01	bench 2 seats, 1 top	712	722	742	761	775	—
	A912 643 __		565	573	595	614	628	—
	A041- - - 01	ganging attachment for bench	74					
	A041- - - __		51					

Finishes Available: • Chrome - 01 • Black - 77 • Med. Grey - 85
Arms: Black ONLY • Nickel - 21 • Pewter - 98 • Taupe - 45

Grade-In Prices and Availability						Approximate Overall Size			Seat		Ht. From Floor		Approx. Weight, Pack & Cube Ydg. Req.
Grade A	Grade B	Grade C	Grade D	Grade E	Grade F	W	D	H	W	D	Seat	Arm	
1,046	1,064	1,081	1,098	1,115	1,133	33	26½	34	30	19	18½	–	44 lbs. 1 Pk SU
966	983	1,001	1,018	1,035	1,053								18.9 CU - 2¼ yds
1,123	1,141	1,158	1,175	1,192	1,210	37	26½	34	30	19	18½	25.8	46 lbs. 1 Pk SU
1,033	1,051	1,068	1,085	1,102	1,120								21.8 CU - 2¼ yds
1,046	1,064	1,081	1,098	1,115	1,133	33	26½	34	30	19	18½	–	46 lbs. 1 Pk SU
966	983	1,001	1,018	1,035	1,053								18.9 CU - 2¼ yds
1,123	1,141	1,158	1,175	1,192	1,210	37	26½	34	30	19	18½	25.8	48 lbs. 1 Pk SU
1,033	1,051	1,068	1,085	1,102	1,120								21.8 CU - 2¼ yds

Finishes Available: • Chrome - 01 • Black - 77 • Pewter - 98

Grade-In Prices and Availability						Approximate Overall Size			Seat		Ht. From Floor		Approx. Weight, Pack & Cube Ydg. Req.
Grade A	Grade B	Grade C	Grade D	Grade E	Grade F	W	D	H	W	D	Seat	Arm	
655	666	677	688	700	710	45	20½	18½	21	20½	18½	–	22 lbs. 1 SU
537	548	560	570	582	593								11.0 CU - 1½ yds
880	897	913	930	947	964	65	20½	18½	21	20½	18½	–	28 lbs. 1 SU
766	783	799	816	833	850								16.0 CU - 2¼ yds
825	835	847	858	869	880	65	20½	18½	21	20½	18½	–	28 lbs. 1 SU
677	688	700	710	722	732								16.0 CU - 1½ yds



PYRAMID WALL-SAVER

• **New!** Pyramid is now available with “wall saver” legs on all versions with exception of the flat top benches. • **Available:** arms, armless, left-hand and right-hand only version. • **Unlimited configurations possible.** • **Frames:** oval tubing with all joints welded for strength and stability. • **Ganging options.** • **Arm caps** textured urethane with metal inner structure. • **Ideal for waiting rooms.** • **In-line tables available.** • **Two back styles:** open or closed to accommodate all situations.

EXAMPLE:

X939 702

2 digits indicate paint finish:
 77 Black
 85 Med. Grey
 21 Nickel
 98 Pewter
 45 Taupe

SEATING Chairs, Metal

Illustration	Item Number	Description	Price and Upholstery Availability					
			Grade I	COM Grade II	Grade III	Grade IV	Grade V	Grade LM
	X939 701 01	Guest Chair	499	525	543	564	583	—
	X939 701 __	Open Back Armless	471	491	508	529	548	—
	X940 702 01	Guest Chair	549	568	590	610	630	—
	X940 702 __	Open Back Arms	513	533	552	572	591	—
	X941 701 01	Guest Chair	499	525	543	564	583	—
	X941 701 __	Full Back Armless	471	491	508	529	548	—
	X942 702 01	Guest Chair	549	568	590	610	630	—
	X942 702 __	Full Back Arms	513	533	552	572	591	—
	X943 70R 01	Guest Chair • Open Back	526	546	565	585	607	—
	X943 70R __	Right Arm Only (Sitting)	493	511	531	551	569	—
	X944 70L 01	Guest Chair • Open Back	526	546	565	585	607	—
	X944 70L __	Left Arm Only (Sitting)	493	511	531	551	569	—
	X945 70R 01	Guest Chair • Full Back	526	546	565	585	607	—
	X945 70R __	Right Arm Only (Sitting)	493	511	531	551	569	—
	X946 70L 01	Guest Chair • Full Back	526	546	565	585	607	—
	X946 70L __	Left Arm Only (Sitting)	493	511	531	551	569	—

PYRAMID WALL-SAVER SPECIAL PURPOSE SEATING

Illustration	Item Number	Description	Price and Upholstery Availability					
			Grade I	COM Grade II	Grade III	Grade IV	Grade V	Grade LM
	X947 801 01	open back	790	829	899	965	1,018	—
	X947 801 __	armless	706	745	813	876	933	—
	X948 802 01	open back	872	911	980	1,042	1,099	—
	X948 802 __	with arms	776	813	883	944	1,003	—
	X949 801 01	closed back	790	829	899	965	1,018	—
	X949 801 __	armless	706	745	813	876	933	—
	X950 802 01	closed back	872	911	980	1,042	1,099	—
	X950 802 __	with arms	776	813	883	944	1,003	—

Finishes Available: • Chrome - 01 • Black - 77 • Med. Grey - 85
Arms: Black ONLY • Nickel - 21 • Pewter - 98 • Taupe - 45

Grade-In Prices and Availability						Approximate Overall Size			Seat		Ht. From Floor		Approx. Weight, Pack & Cube Ydg. Req.
Grade A	Grade B	Grade C	Grade D	Grade E	Grade F	W	D	H	W	D	Seat	Arm	
649	664	678	693	708	723	23	26	34	19 ¹ / ₄	18 ¹ / ₂	18 ¹ / ₂		23 lbs. 1 Pk SU
614	629	643	658	673	688								14.3 CU - 2 yds
695	710	725	740	755	770	26 ³ / ₄	26	34	19 ¹ / ₄	18 ¹ / ₂	18 ¹ / ₂	25	25 lbs. 1 Pk SU
657	672	687	702	717	731								15.38 CU - 2 yds
649	664	678	693	708	723	23	26	34	19 ¹ / ₄	18 ¹ / ₂	18 ¹ / ₂		23 lbs. 1 Pk SU
614	629	643	658	673	688								14.3 CU - 2 yds
695	710	725	740	755	770	26 ³ / ₄	26	34	19 ¹ / ₄	18 ¹ / ₂	18 ¹ / ₂	25	26 lbs. 1 Pk SU
657	672	687	702	717	731								15.38 CU - 2 ¹ / ₂ yds
673	688	703	718	732	747	25	26	34	19 ¹ / ₄	18 ¹ / ₂	18 ¹ / ₂	25	24 lbs. 1 Pk SU
635	650	665	679	694	709								15.38 CU - 2 yds
673	688	703	718	732	747	25	26	34	19 ¹ / ₄	18 ¹ / ₂	18 ¹ / ₂	25	24 lbs. 1 Pk SU
635	650	665	679	694	709								15.38 CU - 2 yds
673	688	703	718	732	747	25	26	34	19 ¹ / ₄	18 ¹ / ₂	18 ¹ / ₂	25	25 lbs. 1 Pk SU
635	650	665	679	694	709								15.38 CU - 2 ¹ / ₂ yds
673	688	703	718	732	747	25	26	34	19 ¹ / ₄	18 ¹ / ₂	18 ¹ / ₂		25 lbs. 1 Pk SU
635	650	665	679	694	709								15.38 CU - 2 ¹ / ₂ yds

Grade-In Prices and Availability						Approximate Overall Size			Seat		Ht. From Floor		Approx. Weight, Pack & Cube Ydg. Req.
Grade A	Grade B	Grade C	Grade D	Grade E	Grade F	W	D	H	W	D	Seat	Arm	
1,095	1,112	1,130	1,146	1,164	1,181	33	27 ¹ / ₂	34	30	19	18 ¹ / ₂	-	44 lbs. 1 Pk SU
1,010	1,027	1,045	1,062	1,079	1,097								18.9 CU - 2 ¹ / ₄ yds
1,176	1,194	1,211	1,228	1,245	1,263	37	27 ¹ / ₂	34	30	19	18 ¹ / ₂	25.8	46 lbs. 1 Pk SU
1,080	1,098	1,115	1,132	1,150	1,167								21.8 CU - 2 ¹ / ₄ yds
1,095	1,112	1,130	1,146	1,164	1,181	33	27 ¹ / ₂	34	30	19	18 ¹ / ₂	-	46 lbs. 1 Pk SU
1,010	1,027	1,045	1,062	1,079	1,097								18.9 CU - 2 ¹ / ₄ yds
1,176	1,194	1,211	1,228	1,245	1,263	37	27 ¹ / ₂	34	30	19	18 ¹ / ₂	25.8	48 lbs. 1 Pk SU
1,080	1,098	1,115	1,132	1,150	1,167								21.8 CU - 2 ¹ / ₄ yds



ISO

- Ideal for general use training rooms, public areas, etc.
- Gliding reclining action is governed by self-adjusting weight leveraging system.
- Four seat and back options.
- Frame is high strength steel tubing.
- Seat & back frames are attached with self-lubricating nylon attachment connectors.
- Ganging attachment available.
- Patented mechanism.

EXAMPLE:

X959 735 __ E

2 digits indicate paint finish:

- 77 Black
- 85 Med. Grey
- 21 Nickel
- 98 Pewter
- 45 Taupe

Illustration	Item Number	Description	Price and Upholstery Availability					
			No Uph.	Grade I	Grade II	Grade III	Grade IV	Grade V
	X959 735 01E	Molded Seat/Back	347	—	—	—	—	—
	X959 735 __ E	Armless	332	—	—	—	—	—
	X960 736 01E	Molded Seat/Back	381	—	—	—	—	—
	X960 736 __ E	with Arms	363	—	—	—	—	—
	X961 735 01E	Upholstered Seat/Back	—	514	528	546	564	584
	X961 735 __ E	Armless	—	490	504	522	541	560
	X962 736 01E	Upholstered Seat/Back	—	551	563	583	602	621
	X962 736 __ E	with Arms	—	528	540	559	579	598
	X963 735 01E	Mesh Back	—	488	498	519	538	558
	X963 735 __ E	Upholstered Seat Armless	—	460	472	491	511	530
	X964 736 01E	Mesh Back	—	514	528	546	564	584
	X964 736 __ E	Upholstered Seat with Arms	—	490	504	522	541	560
	X967 735 01E	Molded Back/	—	463	476	497	515	534
	X967 735 __ E	Upholstered Seat Armless	—	439	452	473	491	510
	X968 736 01E	Molded Back/	—	487	499	520	538	558
	X968 736 __ E	Upholstered Seat with Arms	—	462	475	496	514	533
	A060 — 77	Ganging Attachment for ISO Chairs	6					

QS Chrome ONLY.
MESH ON BACK AVAILABLE IN BLACK ONLY.

EXAMPLE: X959 73R _ E

1 digit indicates paint finish: 7 Black 8 Med. Grey
2 Nickel 9 Pewter 4 Taupe

ISO Tablet Arm Chair

Illustration	Item Number	Description	Price no Upholstery
	X959 73R 1 E	sled frame	546
	X959 73R _ E	Right Tablet (sitting)	533
	X959 73L 1 E	sled frame	546
	X959 73L _ E	Left Tablet (sitting)	533
	X959 73S 1 E	sled frame	578
	X959 73S _ E	Right Tablet - oversize width 16 1/8" depth 11 1/8"	565
	X959 73P 1 E	sled frame	578
	X959 73P _ E	Left Tablet - oversize width 16 1/8" depth 11 1/8"	565

NOTE: This is the X959 735 Iso sled chair with a factory installed tablet arm attachment (Right or Left). Chromcraft's 24 standard laminates. See page 108 for complete list.
QS Ships in 2 days in selected fabrics. See 2-Day QuickShip Brochure.
QS Chrome ONLY.

Finishes Available: • Chrome - 01 • Black - 77 • Med. Grey - 85
Arms: Black ONLY • Nickel - 21 • Pewter - 98 • Taupe - 45
Shell Color: • Ebony - E

Grade-In Prices and Availability						Approximate Overall Size			Seat		Ht. From Floor		Approx. Weight, Pack & Cube Ydg. Req.
Grade A	Grade B	Grade C	Grade D	Grade E	Grade F	W	D	H	W	D	Seat	Arm	
						23½	24¼	33¼	18	18¾	18¼	—	30 lbs. 1 Ctn. SU 12.6 CU
						23½	24¼	33¼	18	18¾	18¼	26½	33 lbs. 1 Ctn. SU 12.6 CU
625	635	643	653	663	672	23½	24¼	33¼	18	18¾	19	—	32 lbs. 1 Ctn. SU 12.6 CU - 1¼ yds
601	611	619	629	638	648								
663	672	681	690	700	709	23½	24¼	33¼	18	18¾	19	26½	35 lbs. 1 Ctn. SU 12.6 CU 1¼ yds.
639	649	657	667	676	686								
590	598	605	626	636	646	23½	24¼	33¼	18	18¾	18¼	—	27 lbs. 1 Ctn. SU 12.6 CU - ¾ yd
563	570	578	599	608	618								
617	624	632	653	663	672	23½	24¼	33¼	18	18¾	18¼	26½	30 lbs. 1 Ctn. SU 12.6 CU - ¾ yd
593	600	607	629	638	648								
567	575	582	603	613	622	23½	24¼	33¼	18	18¾	18¼	—	31 lbs. 1 Ctn. SU 12.6 CU ¾ yds.
543	550	558	579	588	598								
590	598	605	626	636	646	23½	24¼	33¼	18	18¾	18¼	26½	34 lbs. 1 Ctn. SU 12.6 CU ¾ yds.
566	573	581	602	612	621								
						—	—	—	—	—	—	—	1 Pair Per 1 Pack

Finishes Available: • Chrome - 01 • Black - 77 • Med. Grey - 85 • Nickel - 21
• Pewter - 98 • Taupe - 45
Shell Color: • Ebony - E

Grade-In Prices and Availability						Approximate Overall Size			Seat		Ht. From Floor		Approx. Weight, Pack & Cube Ydg. Req.
Grade A	Grade B	Grade C	Grade D	Grade E	Grade F	W	D	H	W	D	Seat	Arm	
N/A	N/A	N/A	N/A	N/A	N/A	26½	31½	33¼	18¼	18¾	18¼	27½	30 lbs. 1 Pk SU 12.6 CU
N/A	N/A	N/A	N/A	N/A	N/A								
N/A	N/A	N/A	N/A	N/A	N/A	26½	31½	33¼	18¼	18¾	18¼	27½	30 lbs. 1 Pk SU 12.6 CU
N/A	N/A	N/A	N/A	N/A	N/A								
N/A	N/A	N/A	N/A	N/A	N/A	26½	31½	33¼	18¼	18¾	18¼	27½	30 lbs. 1 Pk SU 12.6 CU
N/A	N/A	N/A	N/A	N/A	N/A								
N/A	N/A	N/A	N/A	N/A	N/A	26½	31½	33¼	18¼	18¾	18¼	27½	30 lbs. 1 Pk SU 12.6 CU
N/A	N/A	N/A	N/A	N/A	N/A								

Continued on next page...



ISO TABLET

- Ideal for general use training rooms, public areas, etc.
- Gliding reclining action is governed by self-adjusting weight leveraging system.
- Four seat and back options.
- Frame is high strength steel tubing.
- Seat & back frames are attached with self-lubricating nylon attachment connectors.
- Ganging attachment available.
- Patented mechanism.

EXAMPLE: X96_73_ _E

digit indicates:
7 upholstered seat
1_ upholstered seat & back

digit indicates:
tablet size / position
R Right
L Left
S Right Oversize
P Left Oversize

digit indicates
paint finish:
7 Black
8 Med. Grey
2 Nickel
9 Pewter
4 Taupe

SEATING Chairs, Metal

Illustration	Item Number	Description	Price and Upholstery Availability					
			No Uph.	Grade I	Grade II	Grade III	Grade IV	Grade V
	X967 73R 1E	sled frame • molded shell upholstered seat	—	665	685	705	725	745
	X967 73R _E	right tablet (sitting)	—	640	659	678	698	717
	X967 73L 1E	sled frame • molded shell upholstered seat	—	665	685	705	725	745
	X967 73L _E	left tablet (sitting)	—	640	659	678	698	717
	X967 73S 1E	sled frame • molded shell upholstered seat	—	694	715	736	756	777
	X967 73S _E	right tablet-oversize	—	672	692	712	732	753
	X967 73P 1E	sled frame • molded shell upholstered seat	—	694	715	736	756	777
	X967 73P _E	left tablet-oversize	—	672	692	712	732	753
	X961 73R 1E	sled frame • molded shell upholstered seat & back	—	713	734	756	777	799
	X961 73R _E	right tablet (sitting)	—	691	712	732	753	774
	X961 73L 1E	sled frame • molded shell upholstered seat & back	—	713	734	756	777	799
	X961 73L _E	left tablet (sitting)	—	691	712	732	753	774
	X961 73S 1E	sled frame • molded shell upholstered seat & back	—	743	765	788	810	832
	X961 73S _E	right tablet-oversize	—	721	743	764	786	808
	X961 73P 1E	sled frame • molded shell upholstered seat & back	—	743	765	788	810	832
	X961 73P _E	left tablet-oversize	—	721	743	764	786	808

Chromcraft's 24 standard laminates. See page 108 for complete list.

Finishes Available: • Chrome - 01 • Black - 77 • Med. Grey - 85
Arms: Black ONLY • Nickel - 21 • Pewter - 98 • Taupe - 45

Shell Color: • Ebony - E

Grade-In Prices and Availability						Approximate Overall Size			Seat		Ht. From Floor		Approx. Weight, Pack & Cube Ydg. Req.	
Grade A	Grade B	Grade C	Grade D	Grade E	Grade F	W	D	H	W	D	Seat	Arm		
812	824	832	842	853	864	26½	31½	33¼	18	18¾	19	27½	31 lbs.	1 Pk SU
781	793	801	810	821	831								12.6 CU	¾ yds
812	824	832	842	853	864	26½	31½	33¼	18	18¾	19	27½	31 lbs.	1 Pk SU
781	793	801	810	821	831								12.6 CU	¾ yds
847	860	869	878	890	902	26½	36½	33¼	18	18¾	19	27½	31 lbs.	1 Pk SU
820	832	841	850	862	873								12.6 CU	¾ yds
847	860	869	878	890	902	26½	36½	33¼	18	18¾	19	27½	31 lbs.	1 Pk SU
820	832	841	850	862	873								12.6 CU	¾ yds
870	883	892	902	914	926	26½	31½	33¼	18	18¾	19	27½	32 lbs.	1 Pk SU
844	856	865	875	886	898								12.6 CU	1 ¼ yds
870	883	892	902	914	926	26½	31½	33¼	18	18¾	19	27½	32 lbs.	1 Pk SU
844	856	865	875	886	898								12.6 CU	1 ¼ yds
907	920	930	940	953	965	26½	36½	33¼	18	18¾	19	27½	30 lbs.	1 Pk SU
880	893	902	912	925	937								12.6 CU	1 ¼ yds
907	920	930	940	953	965	26½	36½	33¼	18	18¾	19	27½	30 lbs.	1 Pk SU
880	893	902	912	925	937								12.6 CU	1 ¼ yds

Continued on next page...



ISO SERIES - COMPANION

- versatile multifunction seating • big on comfort and application
- chrome or painted frame available • available arm or armless
- with and without casters • Caster version provides mobility
- nest easily for easy access • nest four high

EXAMPLE:
X959 455 __ E

2 digits indicate
paint finish:
77 Black
85 Med. Grey
21 Nickel
98 Pewter
45 Taupe

SEATING Chairs, Metal

Illustration	Item Number	Description	Price and Upholstery Availability					
			No Uph.	Grade I	Grade II	Grade III	Grade IV	Grade V
	Y959 455 01E	Molded Seat/Back No Arms	328	—	—	—	—	—
	Y959 455 __ E	GLIDES	315	—	—	—	—	—
	Y959 4C5 01E	Molded Seat/Back No Arms	328	—	—	—	—	—
	Y959 4C5 __ E	CASTERS	315	—	—	—	—	—
	Y960 456 01E	Molded Seat/Back With Arms	353	—	—	—	—	—
	Y960 456 __ E	GLIDES	340	—	—	—	—	—
	Y960 4C6 01E	Molded Seat/Back With Arms	353	—	—	—	—	—
	Y960 4C6 __ E	CASTERS	340	—	—	—	—	—
	Y961 455 01E	upholstered seat and back glides, armless	482	496	514	533	567	
	Y961 455 __ E		459	472	491	511	531	
	Y961 4C5 01E	upholstered seat and back caster, armless	485	498	517	536	557	
	Y961 4C5 __ E		461	475	493	513	533	
	Y962 456 01E	upholstered seat and back glides, arms	514	528	547	565	585	
	Y962 456 __ E		488	500	519	538	560	
	Y962 4C6 01E	upholstered seat and back casters, arms	518	531	550	569	589	
	Y962 4C6 __ E		493	507	526	545	565	
	Y967 455 01E	molded back / upholstered seat glides, armless	398	404	414	424	435	
	Y967 455 __ E		383	388	399	408	419	
	Y967 4C5 01E	molded back / upholstered seat casters, armless	401	407	418	427	438	
	Y967 4C5 __ E		386	392	403	412	423	
	Y968 456 01E	molded back / upholstered seat glides, arms	431	438	448	458	469	
	Y968 456 __ E		412	419	428	439	449	
	Y968 4C6 01E	molded back / upholstered seat casters, arms	436	441	452	461	472	
	Y968 4C6 __ E		417	423	434	443	454	

Finishes Available: • Chrome - 01 • Black - 77 • Med. Grey - 85
Arms: Black ONLY • Nickel - 21 • Pewter - 98 • Taupe - 45

Shell Color: Ebony - E

Grade-In Prices and Availability						Approximate Overall Size			Seat		Ht. From Floor		Approx. Weight, Pack & Cube Ydg. Req.
Grade A	Grade B	Grade C	Grade D	Grade E	Grade F	W	D	H	W	D	Seat	Arm	
N/A	N/A	N/A	N/A	N/A	N/A	24	25	33 ³ / ₄	18	18 ³ / ₄	18	—	35 lbs. 1 PK SU 12.9 CU
N/A	N/A	N/A	N/A	N/A	N/A	24	25	33 ³ / ₄	18	18 ³ / ₄	18	—	35 lbs. 1 PK SU 12.9 CU
N/A	N/A	N/A	N/A	N/A	N/A	24 ³ / ₄	24	33 ³ / ₄	18	18 ³ / ₄	18	26 ¹ / ₂	38 lbs. 1 PK SU 12.9 CU
N/A	N/A	N/A	N/A	N/A	N/A	24 ³ / ₄	24	33 ³ / ₄	18	18 ³ / ₄	18	26 ¹ / ₂	38 lbs. 1 PK SU 12.9 CU
600	607	615	622	630	637	24	25	33.8	18	18.8	18	—	35 lbs. 1 PK SU 12.9 CU - 1 ¹ / ₄ yds
564	571	579	586	594	601	24	25	33.8	18	18.8	18	—	35 lbs. 1 PK SU 12.9 CU - 1 ¹ / ₄ yds
589	597	604	612	619	626	24	25	33.8	18	18.8	18	—	35 lbs. 1 PK SU 12.9 CU - 1 ¹ / ₄ yds
566	573	581	588	596	603	24	25	33.8	18	18.8	18	—	35 lbs. 1 PK SU 12.9 CU - 1 ¹ / ₄ yds
618	625	633	640	648	655	24.8	24	33.8	18	18.8	18	—	38 lbs. 1 PK SU 12.9 CU - 1 ¹ / ₄ yds
593	600	607	615	622	630	24.8	24	33.8	18	18.8	18	—	38 lbs. 1 PK SU 12.9 CU - 1 ¹ / ₄ yds
622	630	637	644	652	659	24.8	24	33.8	18	18.8	18	—	38 lbs. 1 PK SU 12.9 CU - 1 ¹ / ₄ yds
598	605	613	620	628	635	24.8	24	33.8	18	18.8	18	—	38 lbs. 1 PK SU 12.9 CU - 1 ¹ / ₄ yds
467	475	482	490	497	505	24	25	33.8	18	18.8	18	—	35 lbs. 1 PK SU 12.9 CU - ³ / ₄ yds
452	459	466	474	481	489	24	25	33.8	18	18.8	18	—	35 lbs. 1 PK SU 12.9 CU - ³ / ₄ yds
471	478	485	493	500	508	24	25	33.8	18	18.8	18	—	35 lbs. 1 PK SU 12.9 CU - ³ / ₄ yds
456	463	471	478	485	493	24	25	33.8	18	18.8	18	—	35 lbs. 1 PK SU 12.9 CU - ³ / ₄ yds
501	509	516	524	531	538	24.8	24	33.8	18	18.8	18	—	38 lbs. 1 PK SU 12.9 CU - ³ / ₄ yds
482	490	497	505	512	519	24.8	24	33.8	18	18.8	18	—	38 lbs. 1 PK SU 12.9 CU - ³ / ₄ yds
505	512	519	527	534	542	24.8	24	33.8	18	18.8	18	—	38 lbs. 1 PK SU 12.9 CU - ³ / ₄ yds
487	494	501	509	516	524	24.8	24	33.8	18	18.8	18	—	38 lbs. 1 PK SU 12.9 CU - ³ / ₄ yds

Continued on next page...









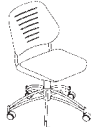
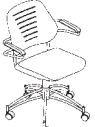

ISO-ST

- Ideal for training rooms, public areas, cubicles, etc.
- Swivel tilt mechanism with upright lock and tension adjustable
- Four seat and back option combinations
- Available arm or armless. • Frame is high strength steel tubing.
- Sturdy five prong base, and gas cylinder for height control.
- Heavy duty Class IV gas cylinder and 55 mm casters standard

EXAMPLE:
X159 420 __ E

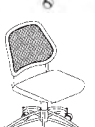
2 digits indicate
paint finish:
77 Black
85 Med. Grey
21 Nickel
98 Pewter
45 Taupe

SEATING Chairs, Metal

Illustration	Item Number	Description	Price and Upholstery Availability					
			No Uph.	Grade I	Grade II	Grade III	Grade IV	Grade V
 QS	Y159 420 01E	Molded Seat/Back	378	—	—	—	—	—
	Y159 420 __ E	Swivel Tilt Armless	351	—	—	—	—	—
 QS	Y160 420 01E	Molded Seat/Back	405	—	—	—	—	—
	Y160 420 __ E	Swivel Tilt with Arms	375	—	—	—	—	—
 QS	Y161 420 01E	Upholstered Seat/Back	—	558	573	591	610	631
	Y161 420 __ E	Swivel Tilt Armless	—	514	528	546	565	586
 QS	Y162 420 01E	Upholstered Seat/Back	—	577	588	607	629	648
	Y162 420 __ E	Swivel Tilt with Arms	—	534	546	565	586	605
 QS	Y163 420 01E	Mesh Back Upholstered Seat	—	514	528	546	565	586
	Y163 420 __ E	Swivel Tilt • Armless	—	471	485	506	524	543
 QS	Y164 420 01E	Mesh Back Upholstered Seat	—	537	551	571	590	608
	Y164 420 __ E	Swivel Tilt • with Arms	—	496	510	530	548	569
 QS	Y165 420 01E	Mesh Back Molded Seat	429	—	—	—	—	—
	Y165 420 __ E	Swivel Tilt • Armless	396	—	—	—	—	—
 QS	Y166 420 01E	Mesh Back Molded Seat	459	—	—	—	—	—
	Y166 420 __ E	Swivel Tilt • with Arms	420	—	—	—	—	—
 QS	Z159 435 01E	Molded Seat/Back	387	—	—	—	—	—
	Z159 435 __ E	Iso Stool Armless	372	—	—	—	—	—
 QS	Z161 435 01E	Upholstered Seat/Back	N/A	558	573	591	610	631
	Z161 435 __ E	Iso Stool Armless	N/A	542	558	577	595	616

MESH ON BACK AVAILABLE IN BLACK ONLY.
QS Chrome ONLY.
QS Ships in 2 days in selected fabrics. See 2-Day QuickShip Brochure.

Numbers below indicate mechanism and base associated per chair series.

Mechanisms

420 Mid pivot swivel tilt with upright lock feature.

Finishes Available: • Chrome - 01 • Black - 77 • Med. Grey - 85

Arms: Black ONLY • Nickel - 21 • Pewter - 98 • Taupe - 45

Shell Color: • Ebony - E

See page 10 for mechanism information.

Grade-In Prices and Availability						Approximate Overall Size			Seat		Ht. From Floor		Approx. Weight, Pack & Cube Ydg. Req.
Grade A	Grade B	Grade C	Grade D	Grade E	Grade F	W	D	H	W	D	Seat	Arm	
						20	22 ¹ / ₄	37 to 33 ³ / ₄	18	18 ³ / ₄	20 ¹ / ₂ to 16 ³ / ₄	–	36 lbs. 1 Ctn. KD 8.6 CU
						23 ¹ / ₂	22 ¹ / ₄	37 to 33 ³ / ₄	18	18 ³ / ₄	20 ¹ / ₂ to 16 ³ / ₄	29 to 25 ¹ / ₄	36 lbs. 1 Ctn. KD 8.6 CU
672 628	682 637	690 646	700 655	709 665	719 674	20	22 ¹ / ₄	37 to 33 ³ / ₄	18	18 ³ / ₄	21 ¹ / ₄ to 17 ¹ / ₂	–	38 lbs. 1 Ctn. KD 8.6 CU 1 ¹ / ₄ yds.
689 647	699 656	707 665	717 674	726 684	736 693	23 ¹ / ₂	22 ¹ / ₄	37 to 33 ³ / ₄	18	18 ³ / ₄	21 ¹ / ₄ to 17 ¹ / ₂	29 to 25 ¹ / ₄	41 lbs. 1 Ctn. KD 8.6 CU 1 ¹ / ₄ yds.
628 584	637 594	646 602	655 612	665 621	674 631	20	27 ¹ / ₄	37 to 33 ³ / ₄	18	18 ³ / ₄	21 ¹ / ₄ to 17 ¹ / ₂	–	36 lbs. 1 Ctn. KD 8.6 CU
650 611	659 620	668 629	677 638	687 648	696 657	23 ¹ / ₂	22 ¹ / ₄	37 to 33 ³ / ₄	18	18 ³ / ₄	21 ¹ / ₄ to 17 ¹ / ₂	29 to 25 ¹ / ₄	39 lbs. 1 Ctn. KD 8.6 CU
						20	22 ¹ / ₄	37 to 33 ³ / ₄	18	18 ³ / ₄	20 ¹ / ₂ to 16 ³ / ₄	–	35 lbs. 1 Ctn. KD 8.6 CU
						23 ¹ / ₂	22 ¹ / ₄	37 to 33 ³ / ₄	18	18 ³ / ₄	20 ¹ / ₂ to 16 ³ / ₄	29 to 25 ¹ / ₄	38 lbs. 1 Ctn. KD 8.6 CU
						20	22 ¹ / ₄	51 to 41	18	18 ³ / ₄	34 ³ / ₄ to 24 ¹ / ₂	–	40 lbs. 1 Ctn. SU 16.5 CU 1 ¹ / ₄ yds.
672 657	682 667	690 675	700 685	709 694	719 704	20	22 ¹ / ₄	51 to 41	18	18 ³ / ₄	35 ¹ / ₂ to 25 ¹ / ₄	–	42 lbs. 1 Ctn. SU 16.5 CU 1 ¹ / ₄ yds.



ASCEND

- Tapered front leg offers unique design.
- Back options feature wood or fully upholstered version.
- Ganging available. • Matching tables available.
- Unique bell shaped seat.
- Spin weld uprights insure clean aesthetics.

EXAMPLE: X969 345

2 digits indicate paint finish:

- 77 Black
- 85 Med. Grey
- 21 Nickel
- 98 Pewter
- 45 Taupe

when applicable letter indicates wood back:

- C Cherry
- J Autumn Oak
- M Mahogany
- W Walnut

Illustration	Item Number	Description	Price and Upholstery Availability					
			Grade I	COM Grade II	Grade III	Grade IV	Grade V	Grade LM
	X969 345 01	Stack Chair Upholstered Back Armless	370	389	405	423	440	–
	X969 345 __		356	375	391	409	426	–
	X970 346 01	Stack Chair Upholstered Back Molded Arms	409	426	443	463	479	–
	X970 346 __		393	410	427	447	463	–
	X971 345 01_	Stack Chair Wood Back Armless	390	408	424	442	461	–
	X971 345 ___		375	393	409	427	446	–
	X972 346 01_	Stack Chair Wood Back Molded Arms	426	443	463	481	497	–
	X972 346 ___		410	427	447	465	481	–

ASCEND Right Arm Only and Left Arm Only

	X973 34R 01	Stack Chair Upholstered Back • Right Arm Only (Sitting)	390	408	424	442	461	–
	X973 34R __		375	393	409	427	446	–
	X974 34L 01	Stack Chair Upholstered Back • Left Arm Only (Sitting)	390	408	424	442	461	–
	X974 34L __		375	393	409	427	446	–
	X975 34R 01_	Stack Chair Wood Back • Right Arm Only (Sitting)	409	426	443	463	479	–
	X975 34R ___		393	410	427	447	463	–
	X976 34L 01_	Stack Chair Wood Back • Left Arm Only (Sitting)	409	426	443	463	479	–
	X976 34L ___		393	410	427	447	463	–
	A070 77	Ganging Attachment for X969 – X976 Black	20					–
	A075 01	Stack Chair Dolly - Chrome	412					–

ASCEND STACKS 4 HIGH.

QS Black Frame ONLY.

QS Ships in 2 days in selected fabrics. See 2-Day QuickShip Brochure.

Metal Finishes Available: • Chrome - 01 • Black - 77 • Med. Grey - 85
Arms: Black ONLY • Nickel - 21 • Pewter - 98 • Taupe - 45

Wood Finishes Available: • Cherry - C • Autumn Oak - J • Mahogany - M
• Walnut - W

Grade-In Prices and Availability						Approximate Overall Size			Seat		Ht. From Floor		Approx. Weight, Pack & Cube Ydg. Req.
Grade A	Grade B	Grade C	Grade D	Grade E	Grade F	W	D	H	W	D	Seat	Arm	
490	500	512	523	534	545	22½	22	34	20½	18¼	18½	—	23 lbs. 1 PK SU
476	487	498	509	520	531								10.5 CU - 1.5 yd
529	540	551	562	573	584	22¾	22	34	20½	18¼	18½	25¾	23 lbs. 1 PK SU
513	524	535	546	558	568								10.5 CU - 1.5 yd
529	540	551	562	573	584	22½	22	34	20½	18¼	18½	—	23 lbs. 1 PK SU
513	524	535	546	558	568								10.5 CU - ½ yd
514	517	522	525	529	533	22¾	22	34	20½	18¼	18½	25¾	23 lbs. 1 PK SU
498	501	506	509	513	517								10.5 CU - ½ yd

511	522	533	544	555	566	22¾	22	34	20½	18¼	18½	25¾	23 lbs. 1 PK SU
496	507	518	529	541	551								10.5 CU - 1.5 yds
511	522	533	544	555	566	22¾	22	34	20½	18¼	18½	25¾	23 lbs. 1 PK SU
496	507	518	529	541	551								10.5 CU - 1.5 yds
496	499	504	507	511	515	22¾	22	34	20½	18¼	18½	25¾	23 lbs. 1 PK SU
480	483	488	491	495	499								10.5 CU - .5 yds
496	499	504	507	511	515	22¾	22	34	20½	18¼	18½	25¾	23 lbs. 1 PK SU
480	483	488	491	495	499								10.5 CU - .5 yds
													18 lbs. 1 CTN KD
													13.2 CU



ASCEND PLUS

New! Ascend Plus is a great addition to our already popular Ascend seating series. Ascend Plus uses double the amount of foam in the seat and back as our standard Ascend series providing a more generous cushion. The Ascend Plus version because of its thickness does effect the nesting capability of the Ascend Plus chairs.

- Tapered front leg offers unique design.
- Back options feature wood or fully upholstered version.
- Ganging available.
- Matching tables available.
- Unique bell shaped seat.
- Spin weld uprights insure clean aesthetics.

EXAMPLE: X969 345

2 digits indicate paint finish:
 77 Black
 85 Med. Grey
 21 Nickel
 98 Pewter
 45 Taupe

when applicable letter indicates wood back:
 C Cherry
 J Autumn Oak
 M Mahogany
 W Walnut

Illustration	Item Number	Description	Price and Upholstery Availability					
			Grade I	COM Grade II	Grade III	Grade IV	Grade V	Grade LM
 QS	Y969 345 01	Stack Chair Upholstered Back	386	405	421	439	456	—
	Y969 345 __	Armless	372	391	407	425	442	—
 QS	Y970 346 01	Stack Chair Upholstered Back	425	442	459	479	495	—
	Y970 346 __	Molded Arms	409	426	443	463	479	—
	Y971 345 01_	Stack Chair Wood Back	406	424	440	458	477	—
	Y971 345 _ _ _	Armless	391	409	425	443	462	—
	Y972 346 01_	Stack Chair Wood Back	442	459	479	497	513	—
	Y972 346 _ _ _	Molded Arms	426	443	463	481	497	—

ASCEND PLUS Right Arm Only and Left Arm Only

	Y973 34R 01	Stack Chair Upholstered Back • Right Arm Only	406	424	440	458	477	—
	Y973 34R __	(Sitting)	391	409	425	443	462	—
	Y974 34L 01	Stack Chair Upholstered Back • Left Arm Only	406	424	440	458	477	—
	Y974 34L __	(Sitting)	391	409	425	443	462	—
	Y975 34R 01_	Stack Chair Wood Back • Right Arm Only	425	442	459	479	495	—
	Y975 34R _ _ _	(Sitting)	409	426	443	463	479	—
	Y976 34L 01_	Stack Chair Wood Back • Left Arm Only	425	442	459	479	495	—
	Y976 34L _ _ _	(Sitting)	409	426	443	463	479	—
	A070 77	Ganging Attachment for X969 – X976 Black	20	—	—	—	—	—
	A075 01	Stack Chair Dolly - Chrome	412	—	—	—	—	—

ASCEND STACKS 4 HIGH.

QS Black Frame ONLY.

QS Ships in 2 days in selected fabrics. See 2-Day QuickShip Brochure.

Metal Finishes Available: • Chrome - 01 • Black - 77 • Med. Grey - 85
Arms: Black ONLY • Nickel - 21 • Pewter - 98 • Taupe - 45

Wood Finishes Available: • Cherry - C • Autumn Oak - J • Mahogany - M
• Walnut - W

Grade-In Prices and Availability							Approximate Overall Size			Seat		Ht. From Floor		Approx. Weight, Pack & Cube Ydg. Req.
Grade A	Grade B	Grade C	Grade D	Grade E	Grade F	W	D	H	W	D	Seat	Arm		
506	516	528	538	550	561	22½	22	34	20½	18¼	18½	—	23 lbs. 1 PK SU	
492	502	514	525	536	547								10.5 CU - 1.5 yd	
545	555	567	578	589	600	22¾	22	34	20½	18¼	18½	25¾	23 lbs. 1 PK SU	
529	540	551	562	573	584								10.5 CU - 1.5 yd	
494	497	501	505	509	513	22½	22	34	20½	18¼	18½	—	23 lbs. 1 PK SU	
479	482	487	490	494	498								10.5 CU - ½ yd	
530	533	537	541	545	549	22¾	22	34	20½	18¼	18½	25¾	23 lbs. 1 PK SU	
514	517	522	525	529	533								10.5 CU - ½ yd	

527	537	549	560	571	582	22¾	22	34	20½	18¼	18½	25¾	23 lbs. 1 PK SU
512	523	534	545	557	567								10.5 CU - 1.5 yds
527	537	549	560	571	582	22¾	22	34	20½	18¼	18½	25¾	23 lbs. 1 PK SU
512	523	534	545	557	567								10.5 CU - 1.5 yds
512	515	519	523	527	531	22¾	22	34	20½	18¼	18½	25¾	23 lbs. 1 PK SU
496	499	504	507	511	515								10.5 CU - .5 yds
512	515	519	523	527	531	22¾	22	34	20½	18¼	18½	25¾	23 lbs. 1 PK SU
496	499	504	507	511	515								10.5 CU - .5 yds
													18 lbs. 1 CTN KD
													13.2 CU



ASCEND TABLES

EXAMPLE:

R961 341 __

2 digits indicate
paint finish:

- 77 Black
- 85 Med. Grey
- 21 Nickel
- 98 Pewter
- 45 Taupe

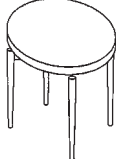
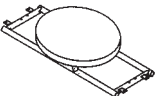
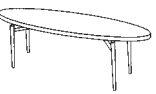
Illustration	Item Number	Description	Table Price		
	R961 341 01	18½" round, 1 ¼" thick,	279		
	R961 341 __	Laminated Top with PVC Edge Molding	263		
	R962 342 01	18½" round, 1 ¼" thick,	243		
	R962 342 __	Suspension Table Laminated Top with PVC Edge Molding	227		
	R963 343 01	48" x 20" Elliptical	354		
	R963 343 __	Magazine Table 17" High	338		

NOTE: R962 TABLE IS NOT FREESTANDING. INSTALLS BETWEEN ASCEND CHAIRS.

Metal Finishes Available: • Chrome - 01 • Black - 77 • Med. Grey - 85
 • Nickel - 21 • Pewter - 98 • Taupe - 45

Grade-In Prices and Availability						Approximate Overall Size			Melamine Plastic Available	Table Weight, Pack & Cube
Grade A	Grade B	Grade C	Grade D	Grade E	Grade F	W	D	H		
						18½	18½	19	Chromcraft's 24 Standard Laminates See Page 108 for complete list.	21 lbs. 1 PK SU 5.1 CU
						18½	18½	19		20 lbs. 1 PK SU 2.5 CU
						20	48	17		21 lbs. 1 PK SU 11.9 CU



PLIANT

- Injection molded one-piece shell of co-polymer polypropylene.
- Back designed to move with you while maintaining control.
- Steel tubing with all welded construction.
- Available with or without upholstered seat and back panels.
- Clean, non-marring polycarbonate glides. • Urethane over steel arm pads.
- Arm and armless versions available.

EXAMPLE:

R989 385

2 digits indicate paint finish:
 77 Black
 85 Med. Grey
 21 Nickel
 98 Pewter
 45 Taupe

SEATING Chairs, Metal

Illustration	Item Number	Shell Color	Description	Price and Upholstery Availability					
				No Uph.	Grade I	Grade II	Grade III	Grade IV	Grade V
 QS	X989 385 01B	Burgundy	Molded Shell	281	—	—	—	—	—
	X989 385 01E	Ebony							
	X989 385 01G	Grey							
	X989 385 01N	Navy							
	X989 385 __ B	Burgundy	No Upholstery	228	—	—	—	—	—
	X989 385 __ E	Ebony							
	X989 385 __ G	Grey							
	X989 385 __ N	Navy							
 QS	X990 386 01B	Burgundy	Molded Shell	324	—	—	—	—	—
	X990 386 01E	Ebony							
	X990 386 01G	Grey							
	X990 386 01N	Navy							
	X990 386 __ B	Burgundy	No Upholstery	269	—	—	—	—	—
	X990 386 __ E	Ebony							
	X990 386 __ G	Grey							
	X990 386 __ N	Navy							
 QS	A09077		Ganging Attachment for Pliant Chairs	24	—	—	—	—	—
 QS	X991 385 01B	Burgundy	Molded Shell	—	396	416	443	465	483
	X991 385 01E	Ebony							
	X991 385 01G	Grey							
	X991 385 01N	Navy							
	X991 385 __ B	Burgundy	Upholstered Seat & Back	—	350	372	396	419	434
	X991 385 __ E	Ebony							
	X991 385 __ G	Grey							
	X991 385 __ N	Navy							
			Armless						

PLIANT (UNUPHOLSTERED) NESTS 5 HIGH.

QS Ebony shell, Black frame ONLY.

QS Ships in 2 days in selected fabrics. See 2-Day QuickShip Brochure.

Finishes Available: • Chrome - 01 • Black - 77 • Med. Grey - 85
 • Nickel - 21 • Pewter - 98 • Taupe - 45

Shell Color: • Burgundy - B • Ebony - E • Grey - G • Navy - N

Grade-In Prices and Availability						Approximate Overall Size			Seat		Ht. From Floor		Approx. Weight, Pack & Cube Ydg. Req.
Grade A	Grade B	Grade C	Grade D	Grade E	Grade F	W	D	H	W	D	Seat	Arm	
						21½	22	36¼	19	19	17¾	—	30 lbs. 1 Ctn. SU 10.8 CU
						21½	22	36¼	19	19	17¾	26¾	32 lbs. 1 Ctn. SU 10.8 CU
						—	—	—	—	—	—	—	1 Pack with Hardware
516	523	531	538	546	553	21½	22	36¼	19	17½	19	—	34 lbs. 1 Ctn. SU 10.8 CU
468	475	483	490	498	505								1 yd.

Continued on next page...



PLIANT

- Injection molded one-piece shell of co-polymer polypropylene.
- Back designed to move with you while maintaining control.
- Steel tubing with all welded construction.
- Available with or without upholstered seat and back panels.
- Clean, non-marring polycarbonate glides. • Urethane over steel arm pads.
- Arm and armless versions available.

EXAMPLE:

R989 385 __

2 digits indicate
paint finish:
77 Black
85 Med. Grey
21 Nickel
98 Pewter
45 Taupe

Illustration	Item Number	Shell Color	Description	Price and Upholstery Availability					
				No Uph.	Grade I	COM Grade II	Grade III	Grade IV	Grade V
	X992 386 01B	Burgundy	Molded Shell	—	435	456	483	504	521
	X992 386 01E	Ebony							
	X992 386 01G	Grey							
	X992 386 01N	Navy							
	X992 386 __ B	Burgundy	Upholstered Seat & Back	—	388	410	434	456	472
	X992 386 __ E	Ebony							
	X992 386 __ G	Grey	Arms	—	388	410	434	456	472
	X992 386 __ N	Navy							
	X997 385 01B	Burgundy	Molded Shell	—	369	384	399	406	417
	X997 385 01E	Ebony							
	X997 385 01G	Grey							
	X997 385 01N	Navy							
	X997 385 __ B	Burgundy	Upholstery Seat	—	323	336	349	355	365
	X997 385 __ E	Ebony							
	X997 385 __ G	Grey							
X997 385 __ N	Navy								
	A09277		Nesting Cart for Pliant	775	—	—	—	—	—

PATTERNS NOT AVAILABLE ON THIS SERIES: REGAL PLIANT (UPHOLSTERED) NESTS 3 HIGH. QS Ebony shell, Black frame ONLY.

Finishes Available: • Chrome - 01 • Black - 77 • Med. Grey - 85
 • Nickel - 21 • Pewter - 98 • Taupe - 45

Shell Color: • Burgundy - B • Ebony - E • Grey - G • Navy - N

Grade-In Prices and Availability						Approximate Overall Size			Seat		Ht. From Floor		Approx. Weight, Pack & Cube Ydg. Req.
Grade A	Grade B	Grade C	Grade D	Grade E	Grade F	W	D	H	W	D	Seat	Arm	
554	562	569	577	584	592	21½	22	36¼	19	17½	19	26¾	36 lbs. 1 Ctn. SU 10.8 CU 1 yd.
505	513	520	528	535	542								
446	454	465	477	490	505	21½	22	36¼	19	19	—	—	32 lbs. 1 ctn SU 10.8 CU 1 yd
391	398	407	418	429	442								
						27½	37¾	53	—	—	—	—	90 lbs. 1 Ctn. SU 31.1 CU

Continued on next page...



PLIANT Tablet Arm Chair

- Injection molded one-piece shell of co-polymer polypropylene.
- Back designed to move with you while maintaining control.
- Steel tubing with all welded construction.
- Available with or without upholstered seat and back panels.
- Clean, non-marring polycarbonate glides.
- Urethane over steel arm pads.
- Arm and armless versions available.
- Tablet arm adjustment device allows 2 1/2" of adjustment space front to back. Tablet lifts for easy entry and exit.
- One chair accommodates more individuals.

Illustration	Item Number	Shell Color	Description	Price and Upholstery Availability					
				No Uph.	Grade I	COM Grade II	Grade III	Grade IV	Grade V
	X989 38R 01B	Burgundy	Molded Shell	468	—	—	—	—	—
	X989 38R 01E	Ebony							
	X989 38R 01G	Grey	No Upholstery						
	X989 38R 01N	Navy							
	X989 38R __ B	See paint legend	Right Tablet	399	—	—	—	—	—
	X989 38R __ E		(sitting)						
	X989 38R __ G								
	X989 38R __ N								
	X989 38L 01B	Burgundy	Molded Shell	468	—	—	—	—	—
	X989 38L 01E	Ebony							
	X989 38L 01G	Grey	No Upholstery						
	X989 38L 01N	Navy							
	X989 38L __ B	See paint legend	Left Tablet	399	—	—	—	—	—
	X992 38L __ E		(sitting)						
	X992 38L __ G								
	X992 38L __ N								

Chromcraft's 24 standard laminates. See page 108 for complete list.



PLIANT ST

- Shell is flexible one-piece co-polymer polypropylene.
- Ideal for conference or meeting rooms.
- Upholstered seat & back available.
- Available with or without arms.
- Arms are width adjustable.
- Unique ergonomic shell provides support in both the upright locked position or in the free float recline position.
- Available in 4 shell colors: black, burgundy, navy, and grey.
- Heavy duty Class IV gas cylinder and 55 mm casters standard

Illustration	Item Number	Shell Color	Description	Price and Upholstery Availability					
				No Uphol.	Grade I	COM Grade II	Grade III	Grade IV	Grade V
QS	X002 121 77B	Burgundy	Shell Chair	261	—	—	—	—	—
	X002 121 77E	Ebony	No Uphol.						
	X002 121 77G	Grey	Armless						
	X002 121 77N	Navy							
QS	X022 121 77B	Burgundy	Shell Chair	373	—	—	—	—	—
	X022 121 77E	Ebony	No Uphol.						
	X022 121 77G	Grey	With Arms						
	X022 121 77N	Navy							
QS	X003 121 77B	Burgundy	Shell Chair	—	434	458	479	504	524
	X003 121 77E	Ebony	Uphol. Seat/Back						
	X003 121 77G	Grey	Armless						
	X003 121 77N	Navy							
QS	X023 121 77B	Burgundy	Shell Chair	—	549	571	594	615	639
	X023 121 77E	Ebony	Uphol. Seat/Back						
	X023 121 77G	Grey	With Arms						
	X023 121 77N	Navy							

PATTERNS NOT AVAILABLE ON THIS SERIES: REGAL QS Ships in 2 days in selected fabrics. See 2-Day QuickShip Brochure. QS Ebony shells ONLY.

2 digits indicate paint finish:
 77 Black
 85 Med. Grey
 21 Nickel
 98 Pewter
 45 Taupe

Finishes Available: • Chrome - 01 • Black - 77 • Med. Grey - 85
 • Nickel - 21 • Pewter - 98 • Taupe - 45

Shell Color: • Burgundy - B • Ebony - E • Grey - G • Navy - N

Grade-In Prices and Availability						Approximate Overall Size			Seat		Ht. From Floor		Approx. Weight, Pack & Cube Ydg. Req.
Grade A	Grade B	Grade C	Grade D	Grade E	Grade F	W	D	H	W	D	Seat	Arm	
						23	31 to 29½	36¼	19	19	17¾	29¼ to 29	42 lbs. 1 Ctn. SU 17.4 CU
						23	31 to 29½	36¼	19	19	17¾	29¼ to 29	42 lbs. 1 Ctn. SU 17.4 CU
						23	31 to 29½	36¼	19	19	17¾	29¼ to 29	42 lbs. 1 Ctn. SU 17.4 CU
						23	31 to 29½	36¼	19	19	17¾	29¼ to 29	42 lbs. 1 Ctn. SU 17.4 CU

Numbers below indicate mechanism and base associated per chair series.

Mechanisms

121 Swivel tilt control with upright lock feature and arm attachment brackets

Finishes Available: • Black - 77

Shell Color: • Burgundy - B • Ebony - E
 • Grey - G • Navy - N

See page 10 for mechanism information.

Grade-In Prices and Availability						Approximate Overall Size			Seat		Ht. From Floor		Approx. Weight, Pack & Cube Ydg. Req.
Grade A	Grade B	Grade C	Grade D	Grade E	Grade F	W	D	H	W	D	Seat	Arm	
						27	25½	38¾ to 34¼	19	19	21 to 16½	–	28 lbs. 1 CTN KD 10.8 CU
						27	25½	38¾ to 34¼	19	19	21 to 16½	29 to 24½	32 lbs. 1 CTN KD 10.8 CU
557	565	572	580	587	595	27	25½	38¾ to 34¼	19	19	21 to 16½	–	31 lbs. 1 CTN KD 10.8 CU
672	679	687	694	702	709	27	25½	38¾ to 34¼	19	19	21 to 16½	29 to 24½	35 lbs. 1 CTN KD 10.8 CU



FACET

• Available with casters or glides • Available with and without arms • Molded plastic arm • Sled version also available • Contoured seat and back, generously proportioned • Waterfall seat front • Stacks five high on the floor • Molded stacking pan protects stacked chairs • Wall saver legs • Available with a tablet arm • Optional bookrack • Stool version • Ganging brackets • Tablet arm adjustment device allows 2 1/2" of adjustment space front to back. Tablet lifts for easy entry and exit. One chair accommodates more individuals. **FACET SPECIAL PURPOSE SEATING** • Facet Bariatric version chairs have been tested in excess of 750 pounds • Full 30" width between the arms • Durable nylon arms resist contamination and infiltration • Can be ganged with standard Facet chairs • Sturdy welded frame with added stretcher for strength

EXAMPLE:

R930 155 __

2 digits indicate paint finish:

- 77 Black
- 85 Med. Grey
- 21 Nickel
- 98 Pewter
- 45 Taupe

SEATING Chairs, Metal

Illustration	Item Number	Description	Price and Upholstery Availability					
			Grade I	COM Grade II	Grade III	Grade IV	Grade V	Grade LM
	Y930 155 01	chair	364	376	393	411	430	
	Y930 155 __	4 leg frame arms, glides	329	340	358	376	394	
	Y930 15C 01	chair	408	420	438	456	474	
	Y930 15C __	4 leg frame arms, casters	373	385	403	420	439	
	Y931 155 01	chair	347	358	376	393	412	
	Y931 155 __	4 leg frame armless, glides	308	321	338	356	375	
	Y931 15C 01	chair	387	399	417	435	453	
	Y931 15C __	4 leg frame armless, casters	351	363	381	398	417	
	Y932 26C 01	lift seat / flip arm	449	461	474	488	498	
	Y932 26C __	4 leg, casters	406	417	430	443	454	
	Y933 25C 01	lift seat / no arm	406	417	430	443	454	
	Y933 25C __	4 leg, casters	361	373	386	399	410	
	Y934 156 01	chair	430	442	460	477	496	
	Y934 156 __	sled frame arms	369	382	399	417	436	
	Y935 156 01	chair	408	420	438	456	474	
	Y935 156 __	sled frame armless	353	365	383	401	419	
	Y937 157 01	4 leg frame tablet arm chair	469	480	498	516	534	
	Y937 157 __	right (sitting)	430	442	460	477	496	
	Y938 158 01	4 leg frame tablet arm chair	469	480	498	516	534	
	Y938 158 __	left (sitting)	430	442	460	477	496	
	Z931 150 01	Stool / armless	413	425	443	461	479	
	Z931 150 __	4 leg frame 30" seat height	358	370	388	406	424	

FACET Special Purpose

	Y950 902 01	open back	746	779	839	891	942	
	Y950 902 __	with arms	642	676	736	788	839	
	Y951 901 01	open back	703	737	797	849	900	
	Y951 901 __	armless	622	656	716	768	819	

QS Ships in 2 days in selected fabrics. See 2-Day QuickShip Brochure. QS Painted Frames ONLY.

Finishes Available: • Chrome - 01 • Black - 77 • Med. Grey - 85
Arms: Black ONLY • Nickel - 21 • Pewter - 98 • Taupe - 45

Grade-In Prices and Availability						Approximate Overall Size			Seat		Ht. From Floor		Approx. Weight, Pack & Cube Ydg. Req.
Grade A	Grade B	Grade C	Grade D	Grade E	Grade F	W	D	H	W	D	Seat	Arm	
472	481	490	499	509	518	25½	22½	33½	19½	19	18½	25½	23 1 PK SU 11.9 cu - 1¼ yds
436	445	454	463	473	482								
515	525	533	543	552	562	25½	22½	33½	19½	19	18½	25½	23 1 PK SU 11.9 cu - 1¼ yds
480	490	498	508	517	527								
454	463	472	481	491	500	22½	22½	33½	19½	19	18½	—	21 1 PK SU 11.9 cu - 1¼ yds
417	426	435	444	454	463								
494	504	512	522	531	541	22½	22½	33½	19½	19	18½	—	21 1 PK SU 11.9 cu - 1¼ yds
458	467	476	485	495	505								
540	549	558	567	577	586	25½	24½	35	19½	19	18½	25½	26 1 PK SU 15½ cu - 1¼ yds
495	505	513	523	532	542								
495	505	513	523	532	542	25½	24½	35	19½	19	18½	—	24 1 PK SU 15½ cu - 1¼ yds
452	461	470	479	489	498								
537	547	555	565	575	584	25½	22½	33½	19½	19	18½	25½	25 1 PK SU 11.9 cu
477	487	495	505	514	524								
515	525	533	543	552	562	22½	22½	33½	19½	19	18½	—	23 1 PK SU 10.3 cu - 1¾ yds
460	470	478	488	497	507								
576	585	594	603	613	622	27½	32	33½	19½	19	18½	27½	30 1 PK SU 20.9 cu - 1¼ yds
537	547	555	565	575	584								
576	585	594	603	613	622	27½	32	33½	19½	19	18½	27½	30 1 PK SU 20.9 cu - 1¼ yds
537	547	555	565	575	584								
520	530	538	548	558	567	22½	22½	45	19½	19	30	—	35 1 PK SU 16.7 cu
465	475	483	493	502	512								

1,012	1,028	1,044	1,059	1,075	1,091	35	24½	34	30	18¼	19¾	26	46 lbs. 1 PK SU 18.6 CU 2¾
909	925	941	956	972	988								
970	986	1,002	1,017	1,033	1,049	32	24½	34	30	18¼	19¾	-	44 lbs. 1 PK SU 18.9 CU 2¾
889	905	921	936	952	968								

Continued on next page...



FACET - MOLDED BACK

Introducing Facet molded backs and Facet flip seats and arms. • New molded back is ideal for high traffic areas • New flip seat / flip arm design for roll and nest chairs • Available with casters or glides • Glides are plastic with stainless steel insets for durability and scuff free use • Multipurpose casters for use on carpet or hard surface floors • Available with and without arms • Molded proprietary plastic arm • Sled version • Compound contoured seat and back are generously proportioned. • Waterfall seat front for extended comfort • Standard anti-tip feature on all versions • Stacks five high on the floor • Molded stacking pan on the seat bottom protects chairs when stacked • Wall saver frame • Tablet arm and an optional bookrack. • Stool version • Optional ganging brackets • Tablet arm adjustment device allows 2 1/2" of adjustment space front to back. Tablet lifts for easy entry and exit. One chair accommodates more individuals.

EXAMPLE:
R940 155 __
2 digits indicate paint finish:
77 Black
85 Med. Grey
21 Nickel
98 Pewter
45 Taupe

SEATING Chairs, Metal

Illustration	Item Number	Description	Price and Upholstery Availability					
			Grade I	COM Grade II	Grade III	Grade IV	Grade V	Grade LM
QS	Y940 155 01	chair	350	360	374	386	398	
	Y940 155 __	4 leg frame arms, glides	315	326	338	352	362	
QS	Y940 15C 01	chair	382	393	406	419	432	
	Y940 15C __	4 leg frame arms, casters	348	358	372	384	395	
QS	Y941 155 01	chair	332	343	356	370	380	
	Y941 155 __	4 leg frame armless, glides	295	306	319	332	343	
QS	Y941 15C 01	chair	361	373	385	399	410	
	Y941 15C __	4 leg frame armless, casters	326	336	350	362	374	
QS	Y942 26C 01	4 leg frame lift seat / flip arm	424	435	447	461	471	
	Y942 26C __	4 leg, casters	380	391	404	417	428	
QS	Y943 25C 01	4 leg frame lift seat / no arm	380	391	404	417	428	
	Y943 25C __	4 leg, casters	336	348	360	374	384	
QS	Y944 156 01	chair	415	426	439	441	453	
	Y944 156 __	sled frame arms	355	365	379	392	403	
QS	Y945 156 01	chair	393	404	417	431	441	
	Y945 156 __	sled frame armless	338	350	362	376	386	
QS	Y947 157 01	4 leg frame tablet arm chair	447	459	471	485	496	
	Y947 157 __	right (sitting)	410	420	434	446	458	
QS	Y948 158 01	4 leg frame tablet arm chair	447	459	471	485	496	
	Y938 158 __	left (sitting)	410	420	434	446	458	
QS	Z941 150 01	Stool / armless	393	404	417	431	441	
	Z941 150 __	4 leg frame 30" seat height	338	350	362	376	386	
QS	AB30--01	accessory	55					
	AB30-- __	book rack	44					
QS	AG30--01	ganging bracket for Facet chairs	79					
	AG30-- __	with arms	60					
QS	AG31--01	ganging bracket for Facet chairs	79					
	AG31-- __	without arms	60					
QS	A930--77	Facet chair cart	208					

QS Ships in 2 days in selected fabrics. See 2-Day QuickShip Brochure. QS Painted Frames ONLY.

Finishes Available: • Chrome - 01 • Black - 77 • Med. Grey - 85
 • Nickel - 21 • Pewter - 98 • Taupe - 45

Back and Arms: Black ONLY

Grade-In Prices and Availability						Approximate Overall Size			Seat		Ht. From Floor		Approx. Weight, Pack & Cube Ydg. Req.
Grade A	Grade B	Grade C	Grade D	Grade E	Grade F	W	D	H	W	D	Seat	Arm	
423	428	434	439	445	450	25½	22½	33½	19½	19	18½	25½	23 1 PK SU 11.9 cu - ¾ yds
387	393	398	403	410	415								
444	449	455	460	466	471	25½	22½	33½	19½	19	18½	25½	23 1 PK SU 11.9 cu - ¾ yds
420	425	431	436	442	447								
405	411	416	421	427	433	25½	22½	33½	19½	19	18½	—	21 1 PK SU 11.9 cu - 1¼ yds
369	374	379	384	391	396								
435	440	445	450	457	462	25½	22½	33½	19½	19	18½	—	21 1 PK SU 11.9 cu - 1¼ yds
399	404	410	415	421	426								
497	502	507	512	519	524	25½	24½	35	19½	19	18½	25½	26 1 PK SU 15½ cu - 1¼ yds
454	459	464	469	476	481								
454	459	464	469	476	481	25½	24½	35	19½	19	18½	—	24 1 PK SU 15½ cu - ¾ yds
410	415	420	425	432	437								
478	483	488	494	500	505	25½	22½	33½	19½	19	18½	25½	25 1 PK SU 11.9 cu
428	434	439	444	450	456								
466	471	477	482	488	494	25½	22½	33½	19½	19	18½	—	23 1 PK SU 11.9 cu
412	417	422	427	434	439								
521	526	531	537	543	548	27½	32	33½	20	19	18½	27½	30 1 PK SU 20.9 cu - ¾ yds
483	488	494	499	505	510								
521	526	531	537	543	548	27½	32	33½	20	19	18½	27½	30 1 PK SU 20.9 cu - ¾ yds
483	488	494	499	505	510								
466	471	477	482	488	494	25½	22½	45	19½	19	30	—	35 1 PK SU 16.7 cu
412	417	422	427	434	439								
						16½	13¾	7¾					5 1 PK 1.3 cu
													5 1 PK 1.3 cu
													5 1 PK 1.3 cu

EXAMPLE:

Z159 435 __ E

2 digits indicate
paint finish:

- 77 Black
- 85 Med. Grey
- 21 Nickel
- 98 Pewter
- 45 Taupe



STOOLS

• Heavy duty Class IV gas cylinder and
55 mm casters standard

SEATING Chairs, Metal

Illustration	Item Number	Description	Price and Upholstery Availability					
			Grade I	COM Grade II	Grade III	Grade IV	Grade V	Grade LM
	Z159 435 01E	Iso Stool	387	N/A	N/A	N/A	N/A	N/A
	Z159 435 __ E	Molded Seat/Back Armless	372	N/A	N/A	N/A	N/A	N/A
	Z161 435 01E	Iso Stool	558	573	591	610	631	N/A
	Z161 435 __ E	Upholstered Seat/Back Armless	542	558	577	595	616	N/A
	Z403 445 77	Ultima II Series Stool • Armless	690	704	736	761	794	N/A
	Z413 445 77	Ultima II Series Stool • Arms	794	807	840	865	900	N/A
	Z103 215 77	Genesis Series • Mid Back syncro mech no arms	664	676	708	737	764	N/A
	Z105 215 77	Genesis Series • Low Back syncro mech no arms	648	660	692	721	749	N/A
	Z205 E15 77	Edge stool, No arms	672	685	713	742	770	N/A
	Z215 E15 77	Edge stool, w/fully adj arms	784	797	825	855	882	N/A
	Z931 150 01	Facet Stool / armless	413	425	443	461	479	N/A
	Z931 150 __	4 leg frame 30" seat height	358	370	388	406	424	N/A
	Z941 150 01	Facet Stool / Molded Back	396	408	421	435	445	N/A
	Z941 150 __	armless 4 leg frame 30" seat height	341	353	366	379	390	N/A

Illustration	Item Number	Frame Finish	Shell Color	Description	Price no upholstery
	Z905 530 01C	Chrome	Cardinal	Vista Stool Molded Seat/Back Armless	226
	Z905 530 01E		Ebony		
	Z905 530 01N		Navy		
	Z905 530 01T		Taupe		
	Z905 530 __ C	Black 77	Cardinal	208	
	Z905 530 __ E	Med Grey 85	Ebony		
	Z905 530 __ N	Nickel 21	Navy		
	Z905 530 __ T	Pewter 98 Taupe 45	Taupe		

PATTERNS NOT AVAILABLE ON THESE STOOLS: REGAL.

Finishes Available: • Chrome - 01 • Black - 77 • Med. Grey - 85
 • Nickel - 21 • Pewter - 98 • Taupe - 45

See page 10 for mechanism information.

Grade-In Prices and Availability							Approximate Overall Size			Seat		Ht. From Floor		Approx. Weight, Pack & Cube Ydg. Req.
Grade A	Grade B	Grade C	Grade D	Grade E	Grade F	W	D	H	W	D	Seat	Arm		
						20	22 ¹ / ₄	51 to 41	18	18 ³ / ₄	34 ³ / ₄ to 24 ¹ / ₂	—	40 lbs. 1 Ctn. SU 16.5 CU 1 ¹ / ₄ yds.	
672	682	690	700	709	719	20	22 ¹ / ₄	51 to 41	18	18 ³ / ₄	35 ¹ / ₂ to 25 ¹ / ₄	—	42 lbs. 1 Ctn. SU 16.5 CU 1 ¹ / ₄ yds.	
657	667	675	685	694	704									
851	865	878	890	904	917	22	27 ¹ / ₂	46 ¹ / ₂ to 39 ³ / ₄	19	19	30 ³ / ₄ to 25 ³ / ₄	—	52 lbs. 1 CTN SU 15.5 CU - 1 ¹ / ₂ yds	
957	971	984	996	1,010	1,023	28 to 25 ¹ / ₂	27 ¹ / ₂	46 ¹ / ₂ to 39 ³ / ₄	19	19	30 ³ / ₄ to 25 ³ / ₄	39 ³ / ₄ to 34 ³ / ₄	67 lbs. 1 CTN SU 15.5 CU - 1 ¹ / ₂ yds	
836	847	859	869	881	891	25	26.25	54.5 to 44.5	20.5	18	32.5 to 26.5	--	42 1 PK SU 16.7 cu - 1 ¹ / ₄ yds	
820	831	843	853	865	876	25	26.25	50 to 40	20.5	18	32.5 to 26.5	--	40 1 PK SU 16.7 cu - 1 ¹ / ₄ yds	
819	830	841	852	863	874	26.5	27.5	54 to 43.5	20	18.5	32 to 24.5	38.5 to 31	40 1 PK SU 16.7 cu	
931	942	953	964	975	986									
520	530	538	548	558	567	22 ¹ / ₂	22 ¹ / ₂	45	19 ¹ / ₂	19	30	—	35 1 PK SU 16.7 cu	
465	475	483	493	502	512									
471	476	481	487	493	498	25 ¹ / ₂	22 ¹ / ₂	45	19 ¹ / ₂	19	30	—	35 1 PK SU 16.7 cu	
416	421	426	431	438	443									

Grade-In Prices and Availability							Approximate Overall Size			Seat		Ht. From Floor		Approx. Weight, Pack & Cube Ydg. Req.
Grade A	Grade B	Grade C	Grade D	Grade E	Grade F	W	D	H	W	D	Seat	Arm		
						19 ³ / ₄	25 ³ / ₄	44 ¹ / ₄	18 ¹ / ₂	19	29 ¹ / ₂	—	28 lbs. 1 Pk SU 15 CU	
N/A														



QUEST WOOD

- Ergonomic design featuring contoured seat and back.
- Executive and management seating feature lumbar support.
- Waterfall seat front for comfortable upper-thigh support.
- 5-prong metal base with wood caps and dual wheel casters.
- Features swivel tilt or knee tilt mechanism both with upright lock
- Sculptured wood arms are available in five wood finishes
- Heavy duty Class IV gas cylinder and 55 mm casters standard

Illustration	Item Number	Description	Price and Upholstery Availability					
			Grade I	COM Grade II	Grade III	Grade IV	Grade V	Grade LM
	X871 260 AC	Executive Chair	846	861	897	955	1,007	1,200
	X871 260 AJ							
	X871 260 AM							
	X871 260 AW							
	X871 290 AC	Executive Chair Knee-Tilt	915	934	966	1,026	1,079	1,264
	X871 290 AJ							
	X871 290 AM							
	X871 290 AW							
	X873 260 AC	Management Chair	839	847	887	943	990	1,125
	X873 260 AJ							
	X873 260 AM							
	X873 260 AW							
	X873 290 AC	Management Chair Knee-Tilt	908	921	958	1,014	1,063	1,203
	X873 290 AJ							
	X873 290 AM							
	X873 290 AW							
	X877 041 AC	Guest Chair	569	608	650	694	738	846
	X877 041 AJ							
	X877 041 AM							
	X877 041 AW							

SEATING Chairs, Wood



ICON WOOD

- Icon Wood employs a fully upholstered arm which continues the thick to thin look on the arm front to back as well as top to bottom.
- Available in Cherry, Mahogany, Walnut or Oak finish.
- Utilizes the same cushion technique as Icon Ultra which employs the thick to thin head rest and thin profile inner seat and back cushions for a crisp clean appearance.
- Same quality construction as Icon and Icon Ultra with the added beauty of a fully upholstered arm and wood base.
- Icon Wood uses a five prong steel base with decorative wood prongs.
- Heavy duty Class IV gas cylinder and 55 mm casters standard

Illustration	Item Number	Wood Finish	Description	Price and Upholstery Availability					
				Grade I	COM Grade II	Grade III	Grade IV	Grade V	Grade LM
	X351 400 AC	Cherry Aut. Oak Mahogany Walnut	Executive Chair knee tilt	998	1,036	1,093	1,152	1,211	1,417
	X351 400 AJ								
	X351 400 AM								
	X351 400 AW								
	X353 400 AC	Cherry Aut. Oak Mahogany Walnut	Management Chair knee tilt	943	979	1,038	1,096	1,155	1,361
	X353 400 AJ								
	X353 400 AM								
	X353 400 AW								
	X357 848 77	Black Metal	Guest Metal Sled (No Wood)	777	813	870	930	988	1,195

Numbers below indicate mechanism and base associated per chair series.

Mechanisms: 260 Mid pivot swivel tilt with upright lock feature. • 290 Knee tilt control with upright lock feature

Finishes Available: • Cherry - AC • Aut. Oak - AJ • Mahogany - AM
• Walnut - AW

See page 10 for mechanism information.

Grade-In Prices and Availability						Approximate Overall Size			Seat		Ht. From Floor		Approx. Weight, Pack & Cube Ydg. Req.
Grade A	Grade B	Grade C	Grade D	Grade E	Grade F	W	D	H	W	D	Seat	Arm	
1,092	1,111	1,131	1,150	1,169	1,188	25¼	26¾	43¼ to 39½	21	19	21½ to 17¾	29½ to 25¾	55 lbs. 1 CTN KD 12.7 CU - 2.5 yds
1,165	1,184	1,203	1,222	1,242	1,261	25¼	26¾	43¼ to 39½	21	19	21½ to 17¾	29½ to 25¾	55 lbs. 1 CTN KD 12.7 CU - 2.5 yds
1,076	1,095	1,114	1,133	1,153	1,172	25¼	26¾	40¼ to 36½	21	19	21½ to 17¾	29¼ to 25¾	51 lbs. 1 CTN KD 11.4 CU - 2.25 yds
1,148	1,167	1,187	1,206	1,225	1,244	25¼	26¾	40¼ to 36½	21	19	21½ to 17¾	29¼ to 25¾	51 lbs. 1 CTN KD 11.4 CU - 2.25 yds
799	812	825	838	851	866	23	26	35½	19¾	19	18½	25¾	38 lbs. 1 CTN SU 14.3 CU - 1.75 yds

Finishes Available: • Cherry - C • Aut. Oak - J • Mahogany - M
• Walnut - W

See page 10 for mechanism information.

Grade-In Prices and Availability						Approximate Overall Size			Seat		Ht. From Floor		Approx. Weight, Pack & Cube Ydg. Req.
Grade A	Grade B	Grade C	Grade D	Grade E	Grade F	W	D	H	W	D	Seat	Arm	
1,318	1,342	1,365	1,390	1,414	1,438	24.75	25	47.5 to 43.75	21	19	21.5 to 17.75	30.25 to 26.5	63 lbs. 1 PK, KD 15.7 CU - 3.25 yds
1,252	1,276	1,299	1,321	1,343	1,365	24.75	25	40.25 to 36.5	21	19	21.5 to 17.75	30.25 to 26.5	59 lbs. 1 PK KD 11.7 CU - 3 yds
1,084	1,109	1,131	1,153	1,176	1,198	24.75	25	36.5	21	19	17.8	26.5	48 lbs. 1 PK KD 15.5 CU - 3 yds



BRETON

- One-piece multi-contoured hardwood plywood shell.
- Steel understructure base with wood caps.
- Distinctive "P" roll-over back design.
- Fully upholstered arms or wood trim arms.
- Knee tilt mechanism with lock and tension control.

Illustration	Item Number	Description	Price and Upholstery Availability					
			Grade I	COM Grade II	Grade III	Grade IV	Grade V	Grade LM
	X131 880 AC	Exec. Chair						
	X131 880 AJ	Fully Uph.	1,205	1,243	1,293	1,356	1,419	1,603
	X131 880 AM	Knee Tilt						
	X131 880 AW							
	X141 880 AC	Exec. Chair						
	X141 880 AJ	Wood Trim	1,442	1,478	1,527	1,589	1,654	1,857
	X141 880 AM	Knee Tilt						
	X141 880 AW							
	X133 880 AC	Mgmt. Chair						
	X133 880 AJ	Fully Uph.	1,128	1,166	1,214	1,276	1,341	1,523
	X133 880 AM	Knee Tilt						
	X133 880 AW							
	X143 880 AC	Mgmt. Chair						
	X143 880 AJ	Wood Trim	1,361	1,399	1,448	1,511	1,575	1,770
	X143 880 AM	Knee Tilt						
	X143 880 AW							
	X147 887 OC	Guest Chair						
	X147 887 OJ	Wood Trim	1,014	1,052	1,092	1,130	1,169	1,328
	X147 887 OM							
	X147 887 OW							
	X148 889 OO	Fully Upholstered Guest with Casters	N/A	982	1,032	1,093	1,159	1,326

SEATING Chairs, Wood

Numbers below indicate mechanism and base associated per chair series.

Mechanisms

880/870 Knee tilt torsion bar control with upright lock out feature.

Finishes Available: • Cherry - C • Aut. Oak - J • Mahogany - M
• Walnut - W

See page 10 for mechanism information.

Grade-In Prices and Availability						Approximate Overall Size			Seat		Ht. From Floor		Approx. Weight, Pack & Cube Ydg. Req.
Grade A	Grade B	Grade C	Grade D	Grade E	Grade F	W	D	H	W	D	Seat	Arm	
1,533	1,558	1,584	1,610	1,636	1,661	26	28	43 ³ / ₄ to 41 ¹ / ₂	19 ¹ / ₂	19 ¹ / ₂	20 ¹ / ₄ to 18	28 ¹ / ₄ to 26	65 lbs. 1 CTN KD 14.2 CU - 3 ¹ / ₂ yds
1,768	1,793	1,820	1,845	1,871	1,896	26	28	43 ³ / ₄ to 41 ¹ / ₂	19 ¹ / ₂	19 ¹ / ₂	20 ¹ / ₄ to 18	28 ¹ / ₄ to 26	65 lbs. 1 CTN KD 14.2 CU - 3 ¹ / ₂ yds
1,455	1,481	1,507	1,532	1,558	1,583	26	28	38 ³ / ₄ to 36 ¹ / ₂	19 ¹ / ₂	19 ¹ / ₂	20 ¹ / ₄ to 18	28 ¹ / ₄ to 26	59 lbs. 1 CTN KD 12.6 CU - 3 ¹ / ₄ yds
1,689	1,715	1,741	1,766	1,792	1,818	26	28	38 ³ / ₄ to 36 ¹ / ₂	19 ¹ / ₂	19 ¹ / ₂	20 ¹ / ₄ to 18	28 ¹ / ₄ to 26	59 lbs. 1 CTN KD 12.6 CU - 3 ¹ / ₄ yds
1,264	1,288	1,310	1,332	1,355	1,377	26 ¹ / ₄	28 ¹ / ₄	34 ¹ / ₄	20	19	19 ³ / ₄	25 ¹ / ₄	34 lbs. 1 CTN SU 16.1 CU - 3 yds
1,305	1,339	1,372	1,405	1,439	1,471	26 ¹ / ₄	28 ¹ / ₄	34 ¹ / ₄	20	19	19 ³ / ₄	25 ³ / ₄	42 lbs. 1 CTN KD 15.2 CU - 4 ¹ / ₂ yds



SOLAS WOOD

- Urethane over steel arms with wood inserts attach under the seat for superior design.
- Extra soft seat and back are ergonomically contoured for proper support and comfort.
- Seat & back feature a one-piece 9 ply hardwood plywood outer shell.
- Loose upholstery technique adds to the soft and supple appearance.
- Available in chrome or black paint version. • “P” rollover cushion at the top of each back.
- Knee-tilt mechanism with lock out feature. • Heavy duty Class IV gas cylinder and 55 mm casters standard

Illustration	Item Number	Description	Price and Upholstery Availability					
			Grade I	COM Grade II	Grade III	Grade IV	Grade V	Grade LM
	X391 140 AC	Executive Chair	1,100	1,135	1,183	1,246	1,306	1,465
	X391 140 AM							
	X391 140 AW							
	X393 140 AC	Management Chair	1,044	1,080	1,128	1,190	1,252	1,385
	X393 140 AM							
	X393 140 AW							
	X397 147 77C	Guest Chair	845	881	918	953	990	1,126
	X397 147 77M							
	X397 147 77W							



SECURA

- Base has wood caps over steel prongs
- Inner seat is curved plywood
- Inner back is hardwood frame
- Arms are fully upholstered
- Heavy duty Class IV gas cylinder and 55 mm casters standard

Illustration	Item Number	Description	Price and Upholstery Availability					
			Grade I	COM Grade II	Grade III	Grade IV	Grade V	Grade LM
	X631 890 AC	Executive Chair Fully Upholstered Knee Tilt • Gas Lift	1,265	1,303	1,364	1,421	1,484	1,648
	X631 890 AJ							
	X631 890 AM							
	X631 890 AW							
	X633 890 AC	Management Chair Fully Upholstered Knee Tilt • Gas Lift	1,230	1,265	1,328	1,383	1,437	1,567
	X633 890 AJ							
	X633 890 AM							
	X633 890 AW							
	X644 487 OJ	Guest Chair	730	782	825	871	905	995
	X644 487 OC							
	X644 487 OM							
	X644 487 OW							
	X444 019 OC	Guest Chair 4-legged Open Arm	635	675	728	773	811	N/A
	X444 019 OJ							
	X444 019 OM							
	X444 019 OW							

REGAL PATTERN NOT AVAILABLE ON THIS SERIES.

Numbers below indicate mechanism and base associated per chair series.

Mechanisms

140 Knee tilt control with upright lock feature

See page 10 for mechanism information.

Finishes Available: • Cherry - C • Mahogany - M • Walnut - W

Grade-In Prices and Availability						Approximate Overall Size			Seat		Ht. From Floor		Approx. Weight, Pack & Cube Ydg. Req.
Grade A	Grade B	Grade C	Grade D	Grade E	Grade F	W	D	H	W	D	Seat	Arm	
1,428	1,456	1,484	1,511	1,538	1,567	26	27	45½ to 42	21	19	21½ to 18	30¼ to 26¾	60 lbs. 1 CTN KD 12.7 CU - ¾ yds
1,373	1,402	1,429	1,456	1,484	1,512	26	26	42½ to 38	21	19	21½ to 18	30¼ to 26¾	57 lbs. 1 CTN KD 11.2 CU - ¾ yds
1,086	1,110	1,132	1,154	1,176	1,198	23	28	36	20	19	18½	26¼	25 lbs. 1 CTN SU 15.0 CU - 3 yds

Numbers below indicate mechanism and base associated per chair series.

Mechanisms

890 Knee tilt torsion bar control with upright lock out feature.

See page 10 for mechanism information.

Finishes Available: • Cherry - C • Aut. Oak - J • Mahogany - M • Walnut - W

Grade-In Prices and Availability						Approximate Overall Size			Seat		Ht. From Floor		Approx. Weight, Pack & Cube Ydg. Req.
Grade A	Grade B	Grade C	Grade D	Grade E	Grade F	W	D	H	W	D	Seat	Arm	
1,591	1,615	1,639	1,663	1,688	1,712	26	28	45¼ to 42¼	19	19½	20½ to 17½	29½ to 26½	62 lbs. 1 CTN KD 13.9 CU - ¾ yds
1,544	1,569	1,592	1,617	1,641	1,665	26	27½	40 to 37	19	19½	20½ to 17½	29½ to 26½	57 lbs. 1 CTN KD 12.6 CU - 3 yds
971	986	1,001	1,015	1,030	1,045	24½	26	33	20½	19	18	26	26 lbs. 1 CTN SU 14.8 CU - ¾ yds
885	902	918	935	952	969	23¼	23½	32¼	20	18	19	25¼	28 lbs. 1 CTN SU 11.9 CU - ¾ yds



TRADITIONAL

- Frames are constructed of select hardwood frame stock, double doweled and glued at all joints.
- High resiliency polyurethane foam with fire retardant chemistry added for comfort, safety and durability.
- Exposed wood frames are finished with oil stains and catalyzed lacquer to provide a durable finish
- Pedestal bases feature styled hardwood prongs over steel understructure
- Pneumatic height adjustment via heavy duty class IV cylinder
- Pedestal chairs are equipped with a tension adjustable swivel tilt mechanism
- Heavy duty dual wheel casters on all pedestal chairs
- X161, X168, X251, X258, X259 chairs include accent brass tacks

Illustration	Item Number	Finish	Description	Price and Upholstery Availability					
				Grade I	COM Grade II	Grade III	Grade IV	Grade V	Grade LM
	X171 220 BC	Cherry	Executive Chair Gas Lift Knee Tilt	N/A	1,440	1,492	1,557	1,608	1,816
	X171 220 BM	Mahogany							
	X171 220 BW	Walnut							
	X177 227 OC	Cherry	Guest Chair 4-Legged	N/A	1,047	1,092	1,136	1,184	1,362
	X177 227 OM	Mahogany							
	X177 227 OW	Walnut							
	X178 228 OC	Cherry	Guest Chair 4-Legged	N/A	876	893	916	930	N/A
	X178 228 OM	Mahogany							
	X178 228 OW	Walnut							
	X179 229 BC	Cherry	Guest Chair 4-Legged With Casters	N/A	843	866	889	911	N/A
	X179 229 BM	Mahogany							
	X179 229 BW	Walnut							
	X161 230 BC	Cherry	Executive Chair Non-tufted Wood Arm Brass Tacks Gas Lift	N/A	1,420	1,501	1,539	1,585	1,672
	X161 230 BM	Mahogany							
	X161 230 BW	Walnut							
	X251 230 BC	Cherry	Executive Chair Button Tufted Upholstered Arm Brass Tacks Gas Lift	N/A	1,746	1,833	1,885	1,956	2,403
	X251 230 BM	Mahogany							
	X251 230 BW	Walnut							
	X168 019 OC	Cherry	Guest Chair 4-legged, High Back Non-tufted Wood Arm Brass Tacks	N/A	1,253	1,326	1,369	1,415	1,501
	X168 019 OM	Mahogany							
	X168 019 OW	Walnut							
	X258 017 OC	Cherry	Guest Chair 4-legged, High Back Button Tufted Upholstered Arm Brass Tacks	N/A	1,457	1,551	1,606	1,681	2,128
	X258 017 OM	Mahogany							
	X258 017 OW	Walnut							
	X259 016 OC	Cherry	Guest Chair 4-legged Wrap around Back Brass Tacks	N/A	1,085	1,163	1,196	1,228	1,379
	X259 016 OM	Mahogany							
	X259 016 OW	Walnut							

Numbers below indicate mechanism and base associated per chair series.

Mechanisms

140 Knee tilt control with upright lock feature

Finishes Available: • Cherry - C • Mahogany - M • Walnut - W

Grade-In Prices and Availability						Approximate Overall Size			Seat		Ht. From Floor		Approx. Weight, Pack & Cube Ydg. Req.
Grade A	Grade B	Grade C	Grade D	Grade E	Grade F	W	D	H	W	D	Seat	Arm	
1699	1722	1743	1764	1785	1806	24½	28½	41	20	18	23½ to 20¼	32 to 28¾	64, 1 CTN KD 12.6 CU, 3 yds
1275	1298	1319	1340	1361	1382	24½	28½	41	20	18	20	27	41, 1 CTN SU 23.8 CU, 3 yds
969	978	986	995	1004	1013	22½	24	34¾	20	17½	19	25	27, 1 CTN SU 11.9 CU, 1¼ yds
973	987	1001	1015	1029	1043	25	24	31	20	18	18½	27	26, 1 CTN SU 12.9 CU, 2 yds
1671	1690	1709	1728	1747	1767	26¾	29	44¾ to 41¾	21	18	20½ to 17½	28 to 25	57, 1 CTN KD 19.5 CU, 2¾ yds
2095	2127	2159	2190	2222	2253	25½	32½	44¾ to 41¾	19½	19¼	20½ to 17½	28 to 25	50, 1 CTN KD 19.5 CU, 4½ yds
1501	1520	1539	1558	1577	1597	26¾	29	42	21	18	18	25¼	40, 1 CTN SU 23.8 CU, 2¾ yds
1820	1852	1884	1915	1947	1978	25½	29	43	19½	19¼	19	25¾	41, 1 CTN SU 23.8 CU, 4½ yds
1314	1333	1352	1371	1390	1410	24	25¾	30½	24½	20½	17½	25¾	30, 1 CTN SU 12.9 CU, 2¼ yds

REVOLUTION

Revolution adds a new twist to linear seating from its unique user friendly Pod unit to its divided linear units. Revolution offers an updated ergonomic appearance with the end-user in mind. • Clear access underneath each unit so items can be stored underneath out of the aisle ways • Linear units with divider tables create a unique "personal space" for each occupant. • Ideal for all forms of public seating; hospitals, universities, airports, courthouses etc. • Utilizes a one piece aluminum leg assembly, spider, and heavy duty steel support bar for its chassis. • A new addition, benches have been added in linear units and seat/table units • 2006 independent surveys have concluded that the divided units receive greater utilization because of the extra "comfort zone" as opposed to standard linear units. • Benches are ideal for areas requiring short term seating or limited space areas • 3" thick seat and 1 5/8" thick back of high resilient molded Ultrafoam®...a Chromcraft exclusive. Ultrafoam is standard with fire retardant chemicals added • Heavy duty 2 1/2" x 2 1/2" x 11-ga. square tube support bar is mounted on die cast polished aluminum bases. • Seats mount to support bar by clamping the aluminum base (or 11-ga. steel clamp brackets) to pre-mounted seat "spiders" with two 5/16" hex head cap screws. • Support bar, clamp brackets, and seat spiders are pre-finished with baked-on finish. • Urethane over steel arm pad for the ultimate in comfort and durability.



Illustration	Item Number	Finish	Description	Price and Upholstery Availability					
				Grade I	COM Grade II	Grade III	Grade IV	Grade V	Grade LM
	L 64 665 02	Chrome	two seats	1,487	1,520	1,574	N/A	N/A	
	L 64 665 77	Black		1,402	1,435	1,490	N/A	N/A	
	L 64 665 92	Pewter	no arms						
	L 65 665 02	Chrome	two seats	1,683	1,717	1,770	N/A	N/A	
	L 65 665 77	Black		1,599	1,633	1,686	N/A	N/A	
	L 65 665 92	Pewter	with arms						
	L 64 666 02	Chrome	three seats	2,020	2,071	2,151	N/A	N/A	
	L 64 666 77	Black		1,893	1,944	2,024	N/A	N/A	
	L 64 666 92	Pewter	no arms						
	L 65 666 02	Chrome	three seats	2,329	2,379	2,460	N/A	N/A	
	L 65 666 77	Black		2,245	2,295	2,376	N/A	N/A	
	L 65 666 92	Pewter	with arms						
	L 64 567 02	Chrome	four seats	2,610	2,678	2,786	N/A	N/A	
	L 64 567 77	Black		2,441	2,508	2,617	N/A	N/A	
	L 64 567 92	Pewter	no arms						
	L 65 567 02	Chrome	four seats	3,003	3,070	3,178	N/A	N/A	
	L 65 567 77	Black		2,835	2,902	3,010	N/A	N/A	
	L 65 567 92	Pewter	with arms						
	L 64 568 02	Chrome	five seats	3,256	3,340	3,476	N/A	N/A	
	L 64 568 77	Black		3,045	3,129	3,263	N/A	N/A	
	L 64 568 92	Pewter	no arms						
	L 65 568 02	Chrome	five seats	3,761	3,846	3,981	N/A	N/A	
	L 65 568 77	Black		3,550	3,634	3,770	N/A	N/A	
	L 65 568 92	Pewter	with arms						
	LH64 666 02	Chrome	2 seats 1 top	1,655	1,688	1,743	N/A	N/A	
	LH64 666 77	Black		1,571	1,604	1,658	N/A	N/A	
	LH64 666 92	Pewter	no arms						
	LH65 666 02	Chrome	2 seats 1 top	1,851	1,885	1,939	N/A	N/A	
	LH65 666 77	Black		1,767	1,801	1,855	N/A	N/A	
	LH65 666 92	Pewter	with arms						
	LM64 567 02	Chrome	3 seats 2 tops	2,386	2,436	2,517	N/A	N/A	
	LM64 567 77	Black		2,259	2,309	2,390	N/A	N/A	
	LM64 567 92	Pewter	no arms						
	LM65 567 02	Chrome	3 seats 2 tops	2,694	2,745	2,826	N/A	N/A	
	LM65 567 77	Black		2,567	2,618	2,699	N/A	N/A	
	LM65 567 92	Pewter	with arms						

STANDARD ON THIS SERIES: Polished Aluminum Bases ONLY
Black Urethane Arm Caps ONLY (on L65 units)
THIS SERIES AVAILABLE IN VINYL ONLY.

MULTIPLE SEATING

Finishes Available: • Chrome and Pol. Alum. - 02 • Pewter - 98 • Black - 77

Arms: Black ONLY

Bases: Polished Aluminum ONLY

Grade-In Prices and Availability						Approximate Overall Size			Seat		Ht. From Floor		Approx. Weight, Pack & Cube Ydg. Req.
Grade A	Grade B	Grade C	Grade D	Grade E	Grade F	W	D	H	W	D	Seat	Arm	
N/A	N/A	N/A	N/A	N/A	N/A	47½	29¼	37½	21	20	18	– 25	104, 2 CTNS 16.5 CU, 3¾ YD
N/A	N/A	N/A	N/A	N/A	N/A	47½	29¼	37½	21	20	18	– 25	111, 2 CTNS 13.8 CU, 3¾ YD
N/A	N/A	N/A	N/A	N/A	N/A	71¼	29¼	37½	21	20	18	– 25	146, 2 CTNS 21.5 CU, 5¾ YD
N/A	N/A	N/A	N/A	N/A	N/A	71¼	29¼	37½	21	20	18	– 25	152, 2 CTNS 27.8 CU, 5¾ YD
N/A	N/A	N/A	N/A	N/A	N/A	95	29¼	37½	21	20	18	– 25	190, 2 CTNS 26.7 CU, 7½ YD
N/A	N/A	N/A	N/A	N/A	N/A	95	29¼	37½	21	20	18	– 25	202, 2 CTNS 27.8 CU, 7½ YD
N/A	N/A	N/A	N/A	N/A	N/A	119	29¼	37½	21	20	18	– 25	232, 2 CTNS 26.7 CU, 9½ YD
N/A	N/A	N/A	N/A	N/A	N/A	119	29¼	37½	21	20	18	– 25	247, 2 CTNS 41.4 CU, 9½ YD
N/A	N/A	N/A	N/A	N/A	N/A	55¾	29¼	37½	21	20	18	– 25	119, 2 CTNS 16.5 CU, 3¾ YD
N/A	N/A	N/A	N/A	N/A	N/A	55¾	29¼	37½	21	20	18	– 25	132, 2 CTNS 13.8 CU, 3¾ YD
N/A	N/A	N/A	N/A	N/A	N/A	87¾	29¼	37½	21	20	18	– 25	174, 2 CTNS 21.5 CU, 5¾ YD
N/A	N/A	N/A	N/A	N/A	N/A	87¾	29¼	37½	21	20	18	– 25	186, 2 CTNS 27.8 CU, 5¾ YD

Continued on next page...



REVOLUTION

Illustration	Item Number	Finish	Description	Price and Upholstery Availability					
				Grade I	COM Grade II	Grade III	Grade IV	Grade V	Grade LM
	LQ64 568 02	Chrome	4 seats 3 tops	3,232	3,301	3,411	N/A	N/A	
	LQ64 568 77	Black		3,060	3,129	3,239	N/A	N/A	
	LQ64 568 92	Pewter	no arms						
	LQ65 568 02	Chrome	4 seats 3 tops	3,633	3,701	3,811	N/A	N/A	
	LQ65 568 77	Black		3,461	3,530	3,640	N/A	N/A	
	LQ65 568 92	Pewter	with arms						
	LP64 636 02	Chrome	Pod unit	4,970	5,073	5,238	N/A	N/A	
	LP64 636 77	Black	6 seats 1 top	4,711	4,814	4,979	N/A	N/A	
	LP64 636 92	Pewter	no arms						

STANDARD ON THIS SERIES: Polished Aluminum Bases ONLY
Black Urethane Arm Caps ONLY (on L65 units)

THIS SERIES AVAILABLE IN VINYL ONLY.



BENCH SEATING

	L 66 665 02	Chrome	two seats	999	1,013	1,043	N/A	N/A	
	L 66 665 77	Black		956	969	999	N/A	N/A	
	L 66 665 92	Pewter							
	L 66 666 02	Chrome	three seats	1,286	1,306	1,351	N/A	N/A	
	L 66 666 77	Black		1,228	1,249	1,294	N/A	N/A	
	L 66 666 92	Pewter							
	L 66 567 02	Chrome	four seats	1,601	1,629	1,687	N/A	N/A	
	L 66 567 77	Black		1,528	1,556	1,616	N/A	N/A	
	L 66 567 92	Pewter							
	L 66 568 02	Chrome	five seats	2,001	2,035	2,110	N/A	N/A	
	L 66 568 77	Black		1,915	1,950	2,024	N/A	N/A	
	L 66 568 92	Pewter							
	LH66 666 02	Chrome	2 seats 1 top	1,228	1,242	1,272	N/A	N/A	
	LH66 666 77	Black		1,184	1,198	1,228	N/A	N/A	
	LH66 666 92	Pewter							
	LM66 567 02	Chrome	3 seats 2 tops	1,630	1,650	1,695	N/A	N/A	
	LM66 567 77	Black		1,572	1,592	1,637	N/A	N/A	
	LM66 567 92	Pewter							
	LQ66 568 02	Chrome	4 seats 3 tops	2,173	2,201	2,260	N/A	N/A	
	LQ66 568 77	Black		2,115	2,143	2,203	N/A	N/A	
	LQ66 568 92	Pewter							

STANDARD ON THIS SERIES: Polished Aluminum Bases ONLY
Black Urethane Arm Caps ONLY (on L65 units)

THIS SERIES AVAILABLE IN VINYL ONLY.

Finishes Available: • Chrome and Pol. Alum. - 02 • Pewter - 98 • Black - 77
Arms: Black ONLY
Bases: Polished Aluminum ONLY

Grade-In Prices and Availability							Approximate Overall Size			Seat		Ht. From Floor		Approx. Weight, Pack & Cube Ydg. Req.
Grade A	Grade B	Grade C	Grade D	Grade E	Grade F	W	D	H	W	D	Seat	Arm		
N/A	N/A	N/A	N/A	N/A	N/A	119¾	29¼	37½	21	20	18	– 25	227, 2 CTNS 26.7CU, 7½ YD	
N/A	N/A	N/A	N/A	N/A	N/A	119¾	29¼	37½	21	20	18	– 25	243, 2 CTNS 27.8CU, 7½ YD	
N/A	N/A	N/A	N/A	N/A	N/A	107½	94¾	37½	21	20	18	–	435, 4 CTNS 54.8CU, 11¼ YD	

N/A	N/A	N/A	N/A	N/A	N/A	47½	24¼	15⅞	21	22½	16⅞	–	57, 2 CTNS 5.6CU, 1½ YD
N/A	N/A	N/A	N/A	N/A	N/A	71¼	24¼	15⅞	21	22½	16⅞	–	76, 2 CTNS 6.8CU, 2½ YD
N/A	N/A	N/A	N/A	N/A	N/A	95	24¼	15⅞	21	22½	16⅞	–	98, 2 CTNS 8.5CU, 3 YD
N/A	N/A	N/A	N/A	N/A	N/A	119	24¼	15⅞	21	22½	16⅞	–	121, 2 CTNS 10.3CU, 3¾ YD
N/A	N/A	N/A	N/A	N/A	N/A	55¾	24¼	15⅞	21	22½	16⅞	–	72, 2 CTNS 5.6CU, 1½ YD
N/A	N/A	N/A	N/A	N/A	N/A	87¾	24¼	15⅞	21	22½	16⅞	–	106, 2 CTNS 8.5CU, 2¼ YD
N/A	N/A	N/A	N/A	N/A	N/A	119¾	24¼	15⅞	21	22½	16⅞	–	136, 2 CTNS 10.3CU, 3 YD

GUARDSMAN



- Seats and backs are separate for easy maintenance
- Units available with or without arms
- Available in chrome and polished aluminum combination
- Back to back ganging attachment available
- Excellent for airports or public areas • Inner construction is molded plywood
- 2 1/2" x 2 1/2" x 11 gauge square support bar for mounting multiple seats
- Tables feature high density particle board laminated on both sides

Illustration	Item Number	Description	Price and Upholstery Availability					
			Grade I	Grade II	Grade III Lariat	Grade IV	Grade V	Grade LM
	L74 665 02	Double Lounge No Arms	1,365	1,407	1,477	N/A	N/A	
	L75 665 02	Double Lounge All Arms	1,814	1,868	1,961	N/A	N/A	
	L74 666 02	Triple Lounge No Arms	2,043	2,105	2,211	N/A	N/A	
	L75 666 02	Triple Lounge All Arms	2,644	2,722	2,857	N/A	N/A	
	L74 667 02	4 Seat Lounge No Arms	2,723	2,806	2,944	N/A	N/A	
	L75 567 02	4 Seat Lounge All Arms	3,472	3,576	3,755	N/A	N/A	
	L74 568 02	5 Seat Lounge No Arms	3,402	3,502	3,678	N/A	N/A	
	L75 568 02	5 Seat Lounge All Arms	4,300	4,431	4,652	N/A	N/A	
	LH74 666 02	Divided Lounge 1 Top 2 Seats No arms	1,587	1,633	1,715	N/A	N/A	
	LJ74 667 02	Divided Lounge 1 Top 3 Seats No arms	2,264	2,332	2,450	N/A	N/A	
	LB74 564 02	Corner Unit 3 Seats (1 + 2) No arms	2,493	2,568	2,696	N/A	N/A	
	LC74 565 02	Corner Unit 4 Seats (2 + 2) No arms	3,172	3,263	3,427	N/A	N/A	
	002-051	1 pr. end arms (1 left, 1 right)	301					

MULTIPLE SEATING

FABRIC NOT AVAILABLE ON THIS SERIES.

VINYLS USED ON THIS SERIES MUST BE A MINIMUM 32 OUNCE VINYL.

OUR 24 STANDARD LAMINATES AVAILABLE ON TABLE TOPS.

Note: Back-to-Back connector bars are available

For Corporate or ADA logos please request quote.

Finishes Available: • Polished Aluminum and Chrome – 02

Grade-In Prices and Availability						Approximate Overall Size			Seat		Ht. From Floor		Approx. Weight, Pack & Cube Ydg. Req.
Grade A	Grade B	Grade C	Grade D	Grade E	Grade F	W	D	H	W	D	Seat	Arm	
						43	27	32½	21	19	17½	—	112 lbs. 1 Pk KD 13.8 CU - 3 yds
						46	27	32½	21	19	17½	25¼	137 lbs. 1 Pk KD 13.8 CU - 3 yds
						70	27	32½	21	19	17½	—	158 lbs. 1 Pk KD 18.6 CU - 4¼ yds
						73	27	32½	21	19	17½	25¼	178 lbs. 1 Pk KD 18.6 CU - 4¼ yds
						94	27	32½	21	19	17½	—	197 lbs. 2 CTNS KD 24.0 CU - 5¾ yds
						97	27	32½	21	19	17½	25¼	224 lbs. 2 CTNS KD 24.0 CU - 5¾ yds
						118	27	32½	21	19	17½	—	240 lbs. 2 CTNS KD 24.0 CU - 7 yds
						121	27	32½	21	19	17½	25¼	197 lbs. 2 CTNS KD 24.0 CU - 7 yds
						70	27	32½	21	19	17½	—	132 lbs. 1 Pk KD 18.6 CU - 3 yds
						94	27	32½	21	19	17½	—	178 lbs. 2 CTNS KD 19.0 CU - 4¼ yds
						84 x 60	27	32½	21	19	17½	—	222 lbs. 2 CTNS KD 23.1 CU - 4¼ yds
						84 x 84	27	32½	21	19	17½	—	255 lbs. 2 CTNS KD 28.1 CU - 5¾ yds
						Chrome with Molded Black cap						13 lbs. 1 CTNS KD .75 CU	



GUARDSMAN II

- No heat-seal / vertical lines
- Seats and backs are separate for easy maintenance
- Units available with or without arms
- Available in chrome and polished aluminum combination
- Back to back ganging attachment available
- Excellent for airports or public areas • Inner construction is molded plywood
- 2 1/2" x 2 1/2" x 11 gauge square support bar for mounting multiple seats
- Tables feature high density particle board laminated on both sides

Illustration	Item Number	Description	Price and Upholstery Availability					
			Grade I	Grade II	Grade III Lariat	Grade IV	Grade V	Grade LM
	L174 665 02	Double Lounge No Arms	1,365	1,407	1,477	N/A	N/A	
	L175 665 02	Double Lounge All Arms	1,814	1,868	1,961	N/A	N/A	
	L174 666 02	Triple Lounge No Arms	2,043	2,105	2,211	N/A	N/A	
	L175 666 02	Triple Lounge All Arms	2,644	2,722	2,857	N/A	N/A	
	L174 667 02	4 Seat Lounge No Arms	2,723	2,806	2,944	N/A	N/A	
	L175 567 02	4 Seat Lounge All Arms	3,472	3,576	3,755	N/A	N/A	
	L174 568 02	5 Seat Lounge No Arms	3,402	3,502	3,678	N/A	N/A	
	L175 568 02	5 Seat Lounge All Arms	4,300	4,431	4,652	N/A	N/A	
	LH14 666 02	Divided Lounge 1 Top 2 Seats No arms	1,587	1,633	1,715	N/A	N/A	
	LJ14 667 02	Divided Lounge 1 Top 3 Seats No arms	2,264	2,332	2,450	N/A	N/A	
	LB14 564 02	Corner Unit 3 Seats (1 + 2) No arms	2,493	2,568	2,696	N/A	N/A	
	LC14 565 02	Corner Unit 4 Seats (2 + 2) No arms	3,172	3,263	3,427	N/A	N/A	
	002-051	1 pr. end arms (1 left, 1 right)	301					

MULTIPLE SEATING

FABRIC NOT AVAILABLE ON THIS SERIES.
VINYLS USED ON THIS SERIES MUST BE A MINIMUM 32 OUNCE VINYL.
OUR 24 STANDARD LAMINATES AVAILABLE ON TABLE TOPS.
Note: Back-to-Back connector bars are available
For Corporate or ADA logos please request quote.

Finishes Available: • Polished Aluminum and Chrome – 02

Grade-In Prices and Availability						Approximate Overall Size			Seat		Ht. From Floor		Approx. Weight, Pack & Cube Ydg. Req.
Grade A	Grade B	Grade C	Grade D	Grade E	Grade F	W	D	H	W	D	Seat	Arm	
						43	27	32½	21	19	17½	—	112 lbs. 1 Pk KD 13.8 CU - 3 yds
						46	27	32½	21	19	17½	25¼	137 lbs. 1 Pk KD 13.8 CU - 3 yds
						70	27	32½	21	19	17½	—	158 lbs. 1 Pk KD 18.6 CU - 4¼ yds
						73	27	32½	21	19	17½	25¼	178 lbs. 1 Pk KD 18.6 CU - 4¼ yds
						94	27	32½	21	19	17½	—	197 lbs. 2 CTNS KD 24.0 CU - 5¾ yds
						97	27	32½	21	19	17½	25¼	224 lbs. 2 CTNS KD 24.0 CU - 5¾ yds
						118	27	32½	21	19	17½	—	240 lbs. 2 CTNS KD 24.0 CU - 7 yds
						121	27	32½	21	19	17½	25¼	197 lbs. 2 CTNS KD 24.0 CU - 7 yds
						70	27	32½	21	19	17½	—	132 lbs. 1 Pk KD 18.6 CU - 3 yds
						94	27	32½	21	19	17½	—	178 lbs. 2 CTNS KD 19.0 CU - 4¼ yds
						84 x 60	27	32½	21	19	17½	—	222 lbs. 2 CTNS KD 23.1 CU - 4¼ yds
						84 x 84	27	32½	21	19	17½	—	255 lbs. 2 CTNS KD 28.1 CU - 5¾ yds
						Chrome with Molded Black cap						13 lbs. 1 CTNS KD .75 CU	

TRADITIONAL LOUNGE



- Frames are constructed of select hardwood frame stock, double doweled and glued at all joints.
- High resiliency polyurethane foam with fire retardant chemistry added for comfort, safety and durability.
- Exposed wood frames are finished with oil stains and catalyzed lacquer to provide a durable finish
- All traditional lounge units include button tufting accents
- All traditional lounge units include accent brass tacks

Illustration	Item Number	Finish	Description	Price and Upholstery Availability					
				Grade I	Grade II	Grade III	Grade IV	Grade V	Grade LM
	X078 214 OC	Cherry	Arm Chair						
	X078 214 OM	Mahogany	Fixed Cushion	N/A	1,448	1,537	1623	1,707	1,772
	X078 214 OW	Walnut							
	L562 502 OC	Cherry	Love Seat						
	L562 502 OM	Mahogany	Loose Cushion	N/A	2,519	2,673	2,837	2,961	3,275
	L562 502 OW	Walnut							
	L563 503 OC	Cherry	Sofa						
	L563 503 OM	Mahogany	Loose Cushion	N/A	3,144	3,313	3,491	3,649	4,327
	L563 503 OW	Walnut							

Numbers below indicate mechanism and base associated per chair series.

Mechanisms

140 Knee tilt control with upright lock feature





Finishes Available: • Cherry - C • Mahogany - M • Walnut - W

Grade-In Prices and Availability						Approximate Overall Size			Seat		Ht. From Floor		Approx. Weight, Pack & Cube Ydg. Req.
Grade A	Grade B	Grade C	Grade D	Grade E	Grade F	W	D	H	W	D	Seat	Arm	
1,863	1,897	1,932	1,967	2,003	2,037	33½	30	32	20	19	19	27	50 lbs. 1 CTN SU 19.5 CU - 5 yds
3,218	3,274	3,333	3,390	3,449	3,505	59½	33¼	34½	43	21½	17¼	25¼	96 lbs. 1 CTN SU 44.6 CU - 8¼ yds
3,992	4,067	4,144	4,221	4,300	4,375	81	33¼	34½	64½	21½	17¼	25¼	134 lbs. 1 CTN SU 60.5 CU - 10½ yds

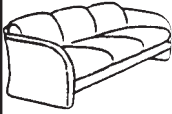
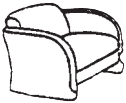

SECURA LOUNGES

- Available as single, two seater, or three seat sofa
- Arm option: fully upholstered or exposed wood
- Available in five wood finishes

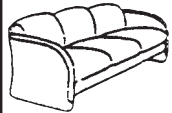
Illustration	Item Number	Description	Price and Upholstery Availability					
			Grade I	COM Grade II	Grade III	Grade IV	Grade V	Grade LM
	L571 341 00	Club Chair Fully Upholstered	1,484	1,539	1,634	1,746	1,861	1,951
	L572 342 00	Love Seat Fully Upholstered	1,997	2,081	2,216	2,374	2,532	2,963
	L573 343 00	Sofa Fully Upholstered	2,393	2,500	2,665	2,868	3,096	3,942
	L581 341 OJ		1,634	1,702	1,796	1,957	2,081	2,102
	L581 341 OC L581 341 OM L581 341 OW	Club Chair Wood Trim	1,698	1,765	1,885	2,022	2,144	2,165
	L582 342 OJ		2,138	2,226	2,374	2,548	2,692	3,100
	L582 342 OC L582 342 OM L582 342 OW	Love Seat Wood Trim	2,196	2,291	2,437	2,615	2,756	3,158
	L583 343 OJ		2,548	2,655	2,835	3,048	3,241	4,095
	L583 343 OC L583 343 OM L583 343 OW	Sofa Wood Trim	2,615	2,722	2,898	3,112	3,306	4,158

LOUNGE SEATING

Finishes Available: • Autumn Oak - J • Cherry - C • Mahogany - M
• Walnut - W

Grade-In Prices and Availability						Approximate Overall Size			Seat		Ht. From Floor		Approx. Weight, Pack & Cube Ydg. Req.
Grade A	Grade B	Grade C	Grade D	Grade E	Grade F	W	D	H	W	D	Seat	Arm	
1,999	2,031	2,061	2,093	2,124	2,156	31	33½	32	25	21½	17½	25	80 lbs. 1 CTN SU 20.7 CU - 5¼ yds
2,727	2,771	2,815	2,859	2,903	2,947	55½	33½	32	49	21½	17½	25	115 lbs. 1 CTN SU 37.3 CU - 7½ yds
3,357	3,416	3,474	3,533	3,592	3,651	80	33½	32	74	21½	17½	25	150 lbs. 1 CTN SU 53.6 CU - 10¼ yds
2,220	2,251	2,283	2,313	2,345	2,376								
2,283	2,314	2,346	2,376	2,408	2,439	30½	33½	32	25	21½	17½	26½	80 lbs. 1 CTN SU 20.7 CU - 5¼ yds
2,888	2,932	2,976	3,020	3,064	3,108								
2,952	2,996	3,040	3,084	3,128	3,172	55	33½	32	49	21½	17½	26½	115 lbs. 1 CTN SU 37.3 CU - 6¼ yds
3,502	3,561	3,619	3,678	3,737	3,796								
3,567	3,626	3,684	3,743	3,802	3,861	79½	33½	32	74	21½	17½	26½	150 lbs. 1 CTN SU 53.6 CU - 9¼ yds



CONFERENCE

• Hour-glass shape top • High density hardwood 1 3/16" thick top • 8' (one-piece) and 10' (two piece) top sizes • Optional twin power and data outlets (CP option) • Self Edge and T-Mold options • 24 standard laminates • Steel base in 6 finishes • Base has leg inserts either in perforated steel mesh or laminate to match the top • Height adjustable glides for leveling

T-mold Edge Table

Illustration	Item Number		Metal Finish	Laminate Panel	Top Shape and Size	Price		Table Price
	Top	Base				TOP	BASE	
	R485	593 Chrome	01	N/A	48 x 120" Hour Glass	898	579	1477
		593	---	---	Two piece top		485	1383
	R486	593 Chrome	01	N/A	48 x 96" Hour Glass	658	579	1237
		593	---	---			485	1143
	R485	594 Chrome	01	---	48 x 120" Hour Glass	898	579	1477
		594	---	---	Two piece top		485	1383
	R486	594 Chrome	01	---	48 x 96" Hour Glass	658	579	1237
		594	---	---			485	1143

Self Edge Table

Illustration	Item Number		Metal Finish	Laminate Panel	Top Shape and Size	Price		Table Price
	Top	Base				TOP	BASE	
	R655	593 Chrome	01	N/A	48 x 120" Hour Glass	998	579	1577
		593	---	---	Two piece top		485	1483
	R656	593 Chrome	01	N/A	48 x 96" Hour Glass	848	579	1427
		593	---	---			485	1333
	R655	594 Chrome	01	---	48 x 120" Hour Glass	998	579	1577
		594	---	---	Two piece top		485	1483
	R656	594 Chrome	01	---	48 x 96" Hour Glass	848	579	1427
		594	---	---			485	1333

Power and Data

	CP	Conference Power Package - Consists of 2 power and data capable outlets, 1-10 ft. power cord, 1-5 ft. color coded jumper cable, factory cut-outs and wire management accessories.	749
--	----	---	-----

ALL WILSON ART LAMINATES AVAILABLE (ON TOPS ONLY) AT A 15% UPCHARGE.

PLEASE SPECIFY METAL FINISH:

593 Base has mesh inserts; available in Chrome, Black, Med. Grey, Nickel, Pewter, Taupe

Please specify metal finish & laminate panel:

594 Base has laminate panels available in our 24 standard laminates and Chrome, Black, Med. Grey, Nickel, Pewter, Taupe.

EXAMPLE:

593 _ _
594 _ _

2 digits indicate paint finish:

77 Black
85 Med. Grey
21 Nickel
98 Pewter
45 Taupe

Finishes Available: • Chrome - 01 • Black - 77 • Med. Grey - 85
 • Nickel - 21 • Pewter - 98 • Taupe - 45





Laminates Available: All 24 Standard Laminates

Edge	Approx. Weight, Pack & Cube		Table Weight, Pack & Cube	Standard Laminates Available	
	Top	Base			
1¼" T Mold	220 lbs. 16.2 CU	40 lbs. 6 CU	260 lbs. 22.2 CU	Antique Brush	Graphite Nebula
1¼" T Mold	206 lbs. 13.1 CU	40 lbs. 6 CU	246 lbs. 22.2 CU	Beryl Brush	Grey Nebula
1¼" T Mold	220 lbs. 16.2 CU	38 lbs. 6 CU	258 lbs. 22.2 CU	Pewter Brush	CF Greystone
1¼" T Mold	206 lbs. 13.1 CU	38 lbs. 6 CU	244 lbs. 22.2 CU	Carbon Ev	Sunstone
				Nickel Ev	Willowstone
				Tungsten Ev	Black
				Bronze Legacy	Dove Grey
				Iron Legacy	Brandy Cherry
				Natural Legacy	Mahogany
				Olive Legacy	Maple
				Beige Nebula	Oak
				White Nebula	Walnut



CONFERENCE

- Wood Base
- Wood Edge Trim
- High Density Hardwood

Illustration	Item Number		Description	Price		Table Price
	Top	Base		TOP	BASE	
	R688A	213 OA Autumn Oak	Round Top wood edge finish matching base	648	609	1,257
	R688C	213 OC Cherry				
	R688M	213 OM Mahogany				
	R688W	213 OW Walnut				
	R596A	214 OA Autumn Oak	Racetrack Top wood edge finish matching base	1,228	876	2,104
	R596C	214 OC Cherry				
	R596M	214 OM Mahogany				
	R596W	214 OW Walnut				
	R595A	214 OA Autumn Oak	Two piece Racetrack Top wood edge finish matching base	1,621	876	2,497
	R595C	214 OC Cherry				
	R595M	214 OM Mahogany				
	R595W	214 OW Walnut				
	R776A	214 OA Autumn Oak	Rectangular Top wood edge finish matching base	1,154	876	2,030
	R776C	214 OC Cherry				
	R776M	214 OM Mahogany				
	R776W	214 OW Walnut				

Power and Data

	CP	Conference Power Package - Consists of 2 power and data capable outlets, 1-10 ft. power cord, 1-5 ft. color coded jumper cable, factory cut-outs and wire management accessories.	749
---	-----------	--	------------

ALL WILSON ART LAMINATES AVAILABLE (ON TOPS ONLY) AT A 15% UPCHARGE.

**Wood Edge Finishes Available: • Autumn Oak - A • Cherry - C • Mahogany - M
• Walnut - W**

Top Size/Shape	Edge	Approx. Weight, Pack & Cube		Table Weight, Pack & Cube	Standard Laminates Available
		Top	Base		
48" Round	1 ¹⁵ / ₁₆ "	95 lbs.	39 lbs.	134 lbs.	Antique Brush
	Wood	1 CTN	1 CTN	2 CTN	Beryl Brush
	Edge	3.7 CU	10.0 CU	13.7 CU	Pewter Brush
48 x 96" Racetrack	1 ¹⁵ / ₁₆ "	206 lbs.	56 lbs.	262 lbs.	Carbon Ev
	Wood	1 CTN	1 CTN	2 CTN	Nickel Ev
	Edge	13.1 CU	9.5 CU	22.6 CU	Tungsten Ev
48 x 120" Racetrack 2 Piece Top	1 ¹⁵ / ₁₆ "	220 lbs.	56 lbs.	276 lbs.	Bronze Legacy
	Wood	1 CTN	1 CTN	2 CTN	Iron Legacy
	Edge	13.1 CU	9.5 CU	22.6 CU	Natural Legacy
48 x 96" Rectangular	1 ¹⁵ / ₁₆ "	220 lbs.	56 lbs.	276 lbs.	Olive Legacy
	Wood	1 CTN	1 CTN	2 CTN	Beige Nebula
	Edge	16.2 CU	9.5 CU	25.7 CU	White Nebula

- Antique Brush
- Beryl Brush
- Pewter Brush
- Carbon Ev
- Nickel Ev
- Tungsten Ev
- Bronze Legacy
- Iron Legacy
- Natural Legacy
- Olive Legacy
- Beige Nebula
- White Nebula
- Graphite Nebula
- Grey Nebula
- CF Greystone
- Sunstone
- Willowstone
- Black
- Dove Grey
- Brandy Cherry
- Mahogany
- Maple
- Oak
- Walnut



CONFERENCE

- Wood Edge Trim • Metal Base
- High Density Hardwood

Illustration	Item Number		Description	Price		Table Price
	Top	Base		TOP	BASE	
	R688A	580	Round Top wood edge finish metal base	648	407	1,055
	R688C	Spread:				
	R688M	Top 36 5/8"				
	R688W	Bottom 30" Height 27 1/2"				



CONFERENCE

- T-Mold Edge
- Top is .040 laminate

Illustration	Item Number		Top Shape and Size	Price		Table Price
	Top	Base Finish		Top	Base	
	R492	455 77 Black	42x72" Racetrack	624	379	1,003
	R496	450 77 Black	48x96" Racetrack	713	447	1,160
	R495		48x120" Racetrack 2 Piece Top	982	447	1,429

Power and Data

	CP	Conference Power Package - Consists of 2 power and data capable outlets, 1-10 ft. power cord, 1-5 ft. color coded jumper cable, factory cut-outs and wire management accessories.	749
--	-----------	---	------------

ALL WILSON ART LAMINATES AVAILABLE (ON TOPS ONLY) AT A 15% UPCHARGE.

Wood Edge Finishes Available: • Autumn Oak - A • Cherry - C • Mahogany - M
• Walnut - W

	Top Size/Shape	Edge	Approx. Weight, Pack & Cube		Table Weight, Pack & Cube	Standard Laminates Available
			Top	Base		
	48" Round	1 ¹⁵ / ₁₆ " Wood Edge	95 lbs. 1 CTN 3.7 CU	14 lbs. 1 CTN 13.9 CU	134 lbs. 2 CTN 13.7 CU	Antique Brush Beryl Brush Pewter Brush Carbon Ev Nickel Ev Tungsten Ev Bronze Legacy Iron Legacy Natural Legacy Olive Legacy Beige Nebula White Nebula Graphite Nebula Grey Nebula CF Greystone Sunstone Willowstone Black Dove Grey Brandy Cherry Mahogany Maple Oak Walnut
<u>T-Mold: Standard shape and Black ONLY</u>						
	Approx. Weight, Pack & Cube		Table Weight, Pack & Cube		Edge	
	Top	Base	Top	Base		
	140 lbs. 1 CTN 7.9 CU	52 lbs. 1 CTN KD 5.2 CU	192 lbs. 2 CTNS 13.1 CU		1 ¹ / ₄ " Edge T Mold Black	
	206 lbs. 1 CTN 13.1 CU	68 lbs. 1 CTN KD 5.7 CU	274 lbs. 2 CTNS 18.8 CU			
	220 lbs. 1 CTN 16.2 CU	68 lbs. 1 CTN KD 5.7 CU	288 lbs. 2 CTNS 21.9 CU			

CONFERENCE

**Standard
Laminates
Available**



590 BASE

• Two Pedestal Bases - Available on 8 Foot and 10 Foot Tops

Illustration	Item Number	Metal Finish	Description	Approx. Weight, Pack & Cube	Price
	590	Chrome-01	Spread: Top 25" ea. Bottom 23 ³ / ₄ " Height 27 ³ / ₄ " Column Size: Two 1 ³ / ₄ " dia. per pedestal	30 lbs. 1 CTN KD 10.6 CU	411
		Black-77			334

Antique Brush
Beryl Brush
Pewter Brush
Carbon Ev
Nickel Ev
Tungsten Ev
Bronze Legacy
Iron Legacy
Natural Legacy
Olive Legacy
Beige Nebula
White Nebula
Graphite Nebula
Grey Nebula
CF Greystone

Sunstone
Willowstone
Black
Dove Grey
Brandy Cherry
Mahogany
Maple
Oak
Walnut



593 / 594 BASE

• Two Pedestal Bases - Available on 8 Foot and 10 Foot Tops

Illustration	Item Number	Metal Finish	Laminate Panel	Description	Approx. Weight, Pack & Cube	Price
	593 Chrome	01	N/A	mesh insert	40 lbs. 6 CU	579
	593	---				485
	594 Chrome	01	---	laminate panel	38 lbs. 6 CU	579
	594	---	---			485

Please specify metal finish:

593 Base has mesh inserts; available in Chrome, Black, Med. Grey, Nickel, Pewter, Taupe

Please specify metal finish & laminate panel:

594 Base has laminate panels available in our 24 standard laminates and Chrome, Black, Med. Grey, Nickel, Pewter, Taupe

EXAMPLE:

593--
594--

2 digits indicate
paint finish:

77 Black
85 Med. Grey
21 Nickel
98 Pewter
45 Taupe

PUB TABLE BASES







Available on 30", 36" and 42" Tops Only

Illustration	Item Number	Finish	Description	Approx. Weight, Pack & Cube	Price
	322 77	Black	Spread: 23 ¹ / ₂ " Height: 40 ¹ / ₂ " Column Size: 6"	40 lbs. 1 CTN KD 6.1 CU	298
		Chrome			319
	572 01 572 77	Black	Spread: 25 ¹ / ₂ " Height: 40 ¹ / ₂ " Column Size: 2 ¹ / ₂ "	40 lbs. 1 CTN KD 6.1 CU	298
		Chrome			319

TOPS & BASES

TOPS SELF-EDGE

Self-edge tops available in our 24 standard laminates ONLY.

<p>Round</p>  <p>R510</p> <p>1 1/4" Self Edge 40 lbs.-1 ctn.-2.1 cu. \$222</p>	<p>Round</p>  <p>R516</p> <p>Square</p>  <p>R546</p> <p>1 1/4" Self Edge 40 lbs.-1 ctn.-2.1 cu. \$250</p>	<p>Round</p>  <p>R512</p> <p>Square</p>  <p>R542</p> <p>1 1/4" Self Edge 59 lbs.-1 ctn.-3.4 cu. \$333</p>	<p>Round</p>  <p>R518</p> <p>1 1/4" Self Edge 82 lbs.-1 ctn.-3.7 cu. \$369</p>	<p>Round</p>  <p>R688A Autumn Oak Edge R688C Cherry Edge R688M Mahogany Edge R688W Walnut Edge</p> <p>1 1/2" Wood Edge 95 lbs.-1 ctn.-3.7 cu. \$648</p>
---	--	--	---	---



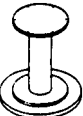
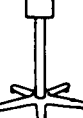
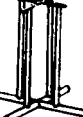
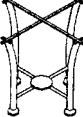



BASES



   	<p>306 77 Black Spread: 23 1/2" Height 27 3/4" Column Size: 6" 30 lbs., 1 ctn., 9.9 cu. \$284</p>	506	534	617	653	932
	<p>540 01 Chrome \$313 540 77 Black \$302 Spread: 25 1/2" Height 27 1/2" Column Size: 2 1/2" 22 lbs., 1 ctn., 12.6 cu.</p>	535 (Chrome) 524 (Paint)	563 (Chrome) 552 (Paint)	646 (Chrome) 635 (Paint)	682 (Chrome) 671 (Paint)	961 (Chrome) 950 (Paint)
	<p>544 01 Chrome \$320 544 77 Black \$302 544 98 Pewter \$302 Spread: 31" Height 27 1/2" Column Size: Four 2" 20 lbs., 1 ctn., 9.9 cu.</p>	N/A	N/A	653 (Chrome) 635 (Paint)	689 (Chrome) 671 (Paint)	968 (Chrome) 950 (Paint)
	<p>580 See Page 104 For Complete Details \$407</p>	N/A	N/A	740	776	1,055

TOPS T MOLD EDGE

T-Mold: Standard shape Black ONLY

BASES

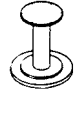
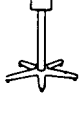
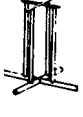
<p>Round</p>  <p>R410</p> <p>40 lbs.-1 ctn.-2.1 cu. \$198</p>	<p>Round</p>  <p>R416</p> <p>Square</p>  <p>R446</p> <p>39 lbs.-1 ctn.-2.1 cu. \$226</p>	<p>Round</p>  <p>R412</p> <p>Square</p>  <p>R442</p> <p>57 lbs.-1 ctn.-3.4 cu. \$270</p>	<p>Round</p>  <p>R488</p> <p>81 lbs.-1 ctn.-3.7 cu. \$324</p>	<p>Round</p>  <p>R480</p> <p>102 lbs.-1 ctn.-5.3 cu. \$436</p>
--	---	---	--	---

   	<p>306 77 Black Spread: 23 1/2" Height 27 3/4" Column Size: 6" 30 lbs., 1 ctn., 9.9 cu. \$284</p>	482	510	554	608	N/A
	<p>540 01 Chrome \$313 540 77 Black \$302 Spread: 25 1/2" Height 27 1/2" Column Size: 2 1/2" 22 lbs., 1 ctn., 12.6 cu.</p>	511 (Chrome) 500 (Paint)	539 (Chrome) 528 (Paint)	583 (Chrome) 572 (Paint)	637 (Chrome) 626 (Paint)	N/A
	<p>544 01 Chrome \$320 544 77 Black \$302 544 98 Pewter \$302 Spread: 31" Height 27 1/2" Column Size: Four 2" 20 lbs., 1 ctn., 9.9 cu.</p>	N/A	N/A	590 (Chrome) 572 (Paint)	644 (Chrome) 626 (Paint)	756 (Chrome) 738 (Paint)
	<p>580 See Page 104 for Complete Details \$407</p>	N/A	N/A	677	731	843

ALL WILSON ART LAMINATES AVAILABLE (ON TOPS ONLY) AT A 15% UPCHARGE. T MOLD EDGE BLACK ONLY



Standard Laminates Available

Antique Brush 02	Bronze Legacy 13	Graphite Nebula 23	Dove Grey 92
Beryl Brush 03	Iron Legacy 14	Grey Nebula 22	Brandy Cherry 49
Pewter Brush 04	Natural Legacy 15	CF Greystone 27	Mahogany 36
Carbon Ev 07	Olive Legacy 16	Sunstone 28	Maple 34
Nickel Ev 08	Beige Nebula 24	Willowstone 29	Oak 52
Tungsten Ev 09	White Nebula 21	Black 91	Walnut 54

Tassk Tables

<u>Paint</u>	<u>No.</u>	<u>Paint</u>	<u>T Mold Color</u>
• available in five paint finishes:	Black	(77)	Black
	Medium Grey	(85)	Medium Grey
	Nickel	(21)	Black
	Pewter	(98)	Black
	Taupe	(45)	Taupe

• T mold edging color is standard with paint color selected.

• available in three T mold edge shapes:	S	Standard	
	B	Bullnose	
	F	Fluted	

• wire management, optional (all grommets and covers match T mold color)

• available in our 24 standard laminates @ standard price.

• All Wilson Art laminates available at a 15% Upcharge.

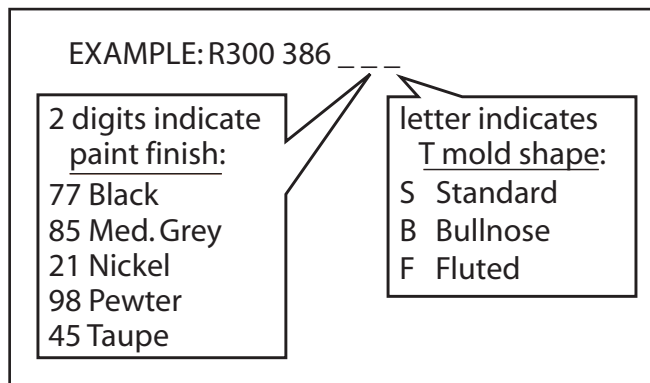



TASSK TABLES

(new leg, arch foot)

These tables with folding legs and optional modesty panel have a folding modesty panel on the 30" width tops. The 24" and 18" width tops have a detachable modesty panel (attaches with hand knobs).

EXAMPLE: R300 386 _ _ _

2 digits indicate paint finish:

77 Black
85 Med. Grey
21 Nickel
98 Pewter
45 Taupe

letter indicates T mold shape:

S Standard
B Bullnose
F Fluted

Rectangular Top

Folding legs with insert / with modesty panel

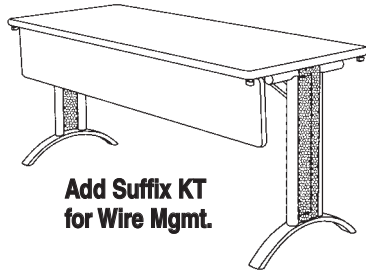

Add Suffix KT for Wire Mgmt.

ITEM NUMBER	TOP SIZE	TOTAL WEIGHT	CUBIC FEET	PRICE
R380 328 _ _ _	18 x 60	78	4.9	961
R382 328 _ _ _	18 x 72	97	5.9	1023
R340 328 _ _ _	24 x 60	119	6.3	992
R342 328 _ _ _	24 x 72	138	7.6	1053
R300 328 _ _ _	30 x 60	140	7.8	1023
R302 328 _ _ _	30 x 72	162	9.2	1082
KT	Factory installed grommets (one left, one right)			112
KS	Factory installed single center grommet			75

Folding legs without insert / with modesty panel

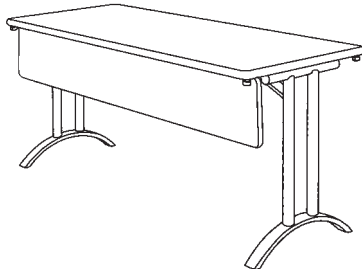

R380 228 _ _ _	18 x 60	76	4.9	887
R382 228 _ _ _	18 x 72	95	5.9	946
R340 228 _ _ _	24 x 60	117	6.3	917
R342 228 _ _ _	24 x 72	136	7.6	977
R300 228 _ _ _	30 x 60	137	7.8	946
R302 228 _ _ _	30 x 72	160	9.2	1007

Folding legs with insert / no modesty panel

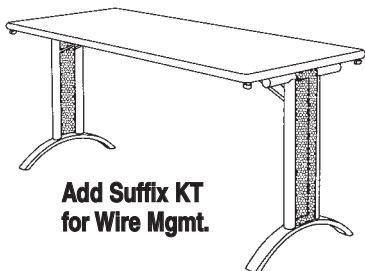

Add Suffix KT for Wire Mgmt.

R280 328 _ _ _	18 x 60	62	3.8	761
R282 328 _ _ _	18 x 72	75	4.5	794
R240 328 _ _ _	24 x 60	103	4.9	790
R242 328 _ _ _	24 x 72	116	5.8	822
R200 328 _ _ _	30 x 60	122	6.0	819
R202 328 _ _ _	30 x 72	139	7.1	851
KT	Factory installed grommets (one left, one right)			112
KS	Factory installed single center grommet			75

Folding legs without insert / no modesty panel

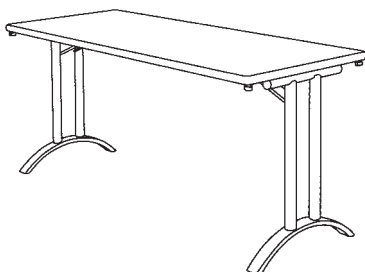

R280 228 _ _ _	18 x 60	60	3.8	687
R282 228 _ _ _	18 x 72	73	4.5	720
R240 228 _ _ _	24 x 60	101	4.9	716
R242 228 _ _ _	24 x 72	114	5.8	749
R200 228 _ _ _	30 x 60	120	6.0	744
R202 228 _ _ _	30 x 72	137	7.1	777

WIRE MANAGEMENT: KS AND KT CAN BE ADDED TO THE ITEM NUMBER AND THE WIRE MANAGEMENT KIT WILL BE FACTORY INSTALLED.

Rectangular Top (cont.) (new leg, arch foot)

Fixed legs with insert / fixed modesty panel

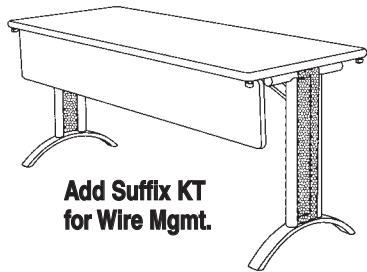

**Add Suffix KT
for Wire Mgmt.**

ITEM NUMBER	TOP SIZE	TOTAL WEIGHT	CUBIC FEET	PRICE
R388 318 _ _ _	18 x 48	59	5.8	725
R380 318 _ _ _	18 x 60	78	4.9	837
R382 318 _ _ _	18 x 72	97	5.9	888
R348 318 _ _ _	24 x 48	100	5.5	756
R340 318 _ _ _	24 x 60	119	6.3	867
R342 318 _ _ _	24 x 72	138	7.6	918
R308 318 _ _ _	30 x 48	116	5.9	785
R300 318 _ _ _	30 x 60	140	7.8	898
R302 318 _ _ _	30 x 72	162	9.2	949
KT	Factory installed grommets (one left, one right)			112
KS	Factory installed single center grommet			75

Fixed legs without insert / fixed modesty panel

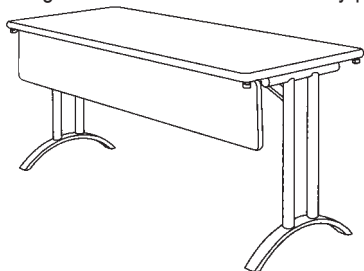

R388 218 _ _ _	18 x 48	57	5.8	596
R380 218 _ _ _	18 x 60	76	6.3	633
R382 218 _ _ _	18 x 72	95	7.6	669
R348 218 _ _ _	24 x 48	98	5.5	626
R340 218 _ _ _	24 x 60	117	6.3	792
R342 218 _ _ _	24 x 72	136	7.6	845
R308 218 _ _ _	30 x 48	114	5.9	711
R300 218 _ _ _	30 x 60	137	7.8	822
R302 218 _ _ _	30 x 72	160	9.2	873

Fixed legs with insert / no modesty panel

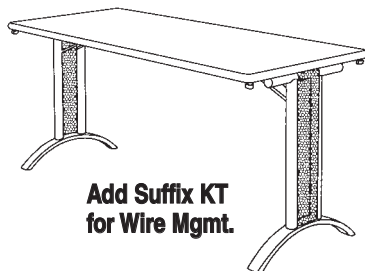

**Add Suffix KT
for Wire Mgmt.**

R288 318 _ _ _	18 x 48	46	4.5	635
R280 318 _ _ _	18 x 60	62	3.8	672
R282 318 _ _ _	18 x 72	75	4.5	707
R248 318 _ _ _	24 x 48	87	4.1	664
R240 318 _ _ _	24 x 60	103	4.9	701
R242 318 _ _ _	24 x 72	116	5.8	738
R208 318 _ _ _	30 x 48	103	4.5	693
R200 318 _ _ _	30 x 60	122	6.0	731
R202 318 _ _ _	30 x 72	139	7.1	765
KT	Factory installed grommets (one left, one right)			112
KS	Factory installed single center grommet			75

Fixed legs without insert / no modesty panel



R288 218 _ _ _	18 x 48	44	4.5	561
R280 218 _ _ _	18 x 60	60	3.8	596
R282 218 _ _ _	18 x 72	73	4.5	633
R248 218 _ _ _	24 x 48	85	4.1	590
R240 218 _ _ _	24 x 60	101	4.9	626
R242 218 _ _ _	24 x 72	114	5.8	663
R208 218 _ _ _	30 x 48	101	4.5	618
R200 218 _ _ _	30 x 60	120	6.0	655
R202 218 _ _ _	30 x 72	137	7.1	692

WIRE MANAGEMENT: KS AND KT CAN BE ADDED TO THE ITEM NUMBER AND THE WIRE MANAGEMENT KIT WILL BE FACTORY INSTALLED.



TASSK TABLES

Cantilever Legs

EXAMPLE: R300 386

2 digits indicate
paint finish:
77 Black
85 Med. Grey
21 Nickel
98 Pewter
45 Taupe

letter indicates
T mold shape:
S Standard
B Bullnose
F Fluted

Rectangular Top — Cantilever Legs

Folding legs with insert / folding modesty panel

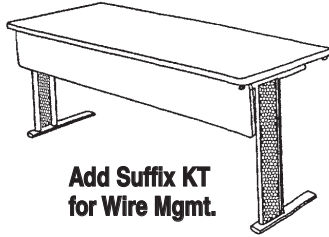

ITEM NUMBER	TOP SIZE	TOTAL WEIGHT	CUBIC FEET	PRICE
N/A	18 x 48	—	—	—
R380 381	18 x 60	78	4.9	860
R382 381	18 x 72	97	5.9	918
N/A	24 x 48	—	—	—
R340 386	24 x 60	119	6.3	888
R342 386	24 x 72	138	7.6	950
N/A	30 x 48	—	—	—
R300 386	30 x 60	140	7.8	918
R302 386	30 x 72	162	9.2	979
KT	Factory installed grommets (one left, one right)			112
KS	Factory installed single center grommet			75

Folding legs without insert / folding modesty panel

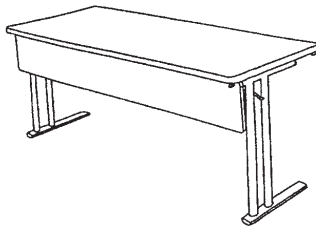

N/A	18 x 48	—	—	—
R380 281	18 x 60	76	4.9	784
R382 281	18 x 72	95	5.9	844
N/A	24 x 48	—	—	—
R340 286	24 x 60	117	6.3	813
R342 286	24 x 72	136	7.6	874
N/A	30 x 48	—	—	—
R300 286	30 x 60	137	7.8	844
R302 286	30 x 72	160	9.2	903

Folding legs with insert / no modesty panel

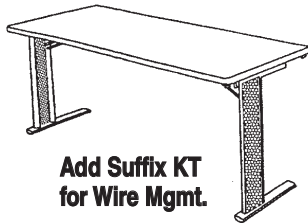

N/A	18 x 48	—	—	—
R280 381	18 x 60	62	3.8	658
R282 381	18 x 72	75	4.5	691
N/A	24 x 48	—	—	—
R240 386	24 x 60	103	4.9	688
R242 386	24 x 72	116	5.8	719
N/A	30 x 48	—	—	—
R200 386	30 x 60	122	6.0	717
R202 386	30 x 72	139	7.1	750
KT	Factory installed grommets (one left, one right)			112
KS	Factory installed single center grommet			75

Folding legs without insert / no modesty panel

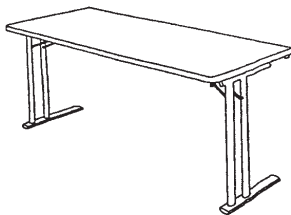

N/A	18 x 48	—	—	—
R280 281	18 x 60	60	3.8	585
R282 281	18 x 72	73	4.5	615
N/A	24 x 48	—	—	—
R240 286	24 x 60	101	4.9	612
R242 286	24 x 72	114	5.8	645
N/A	30 x 48	—	—	—
R200 286	30 x 60	120	6.0	643
R202 286	30 x 72	137	7.1	675

WIRE MANAGEMENT: KS AND KT CAN BE ADDED TO THE ITEM NUMBER AND THE WIRE MANAGEMENT KIT WILL BE FACTORY INSTALLED.

Rectangular Top — Cantilever Legs (cont.)

Fixed legs with insert / fixed modesty panel

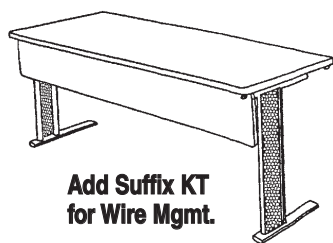

Add Suffix **KT**
for Wire Mgmt.

ITEM NUMBER	TOP SIZE	TOTAL WEIGHT	CUBIC FEET	PRICE
R388 371 _ _ _	18 x 48	59	5.8	660
R380 371 _ _ _	18 x 60	78	4.9	773
R382 371 _ _ _	18 x 72	97	5.9	824
R348 376 _ _ _	24 x 48	100	5.5	692
R340 376 _ _ _	24 x 60	119	6.3	803
R342 376 _ _ _	24 x 72	138	7.6	854
R347 377 _ _ _	24 x 84	140	9.2	1065
R346 377 _ _ _	24 x 96	160	10.1	1124
R308 376 _ _ _	30 x 48	116	5.9	720
R300 376 _ _ _	30 x 60	140	7.8	834
R302 376 _ _ _	30 x 72	162	9.2	884
R307 377 _ _ _	30 x 84	155	10.8	1136
R306 377 _ _ _	30 x 96	175	11.7	1234
KT	Factory installed grommets (one left, one right)			112
KS	Factory installed single center grommet			75

Fixed leg without insert / fixed modesty panel

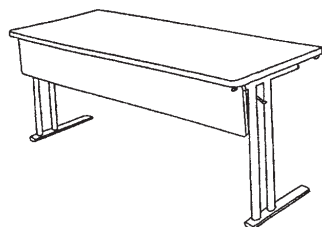

R388 271 _ _ _	18 x 48	57	5.8	587
R380 271 _ _ _	18 x 60	76	6.3	699
R382 271 _ _ _	18 x 72	95	7.6	750
R348 276 _ _ _	24 x 48	98	5.5	615
R340 276 _ _ _	24 x 60	117	6.3	727
R342 276 _ _ _	24 x 72	136	7.6	780
R308 276 _ _ _	30 x 48	114	5.9	646
R300 276 _ _ _	30 x 60	137	7.8	757
R302 276 _ _ _	30 x 72	160	9.2	807

Fixed legs with insert / no modesty panel

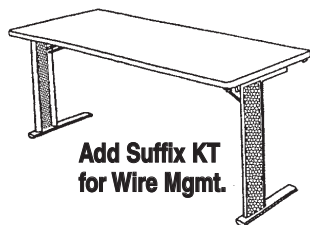

Add Suffix **KT**
for Wire Mgmt.

R288 371 _ _ _	18 x 48	46	4.5	572
R280 371 _ _ _	18 x 60	62	3.8	608
R282 371 _ _ _	18 x 72	75	4.5	644
R248 376 _ _ _	24 x 48	87	4.1	599
R240 376 _ _ _	24 x 60	103	4.9	636
R242 376 _ _ _	24 x 72	116	5.8	673
R247 377 _ _ _	24 x 84	120	9.2	806
R246 377 _ _ _	24 x 96	140	10.1	837
R208 376 _ _ _	30 x 48	103	4.5	629
R200 376 _ _ _	30 x 60	122	6.0	667
R202 376 _ _ _	30 x 72	139	7.1	701
R207 377 _ _ _	30 x 84	130	10.8	874
R206 377 _ _ _	30 x 96	150	11.7	944
KT	Factory installed grommets (one left, one right)			112
KS	Factory installed single center grommet			75

Fixed leg without insert / no modesty panel

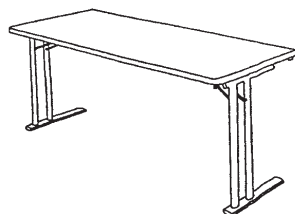

R288 271 _ _ _	18 x 48	44	4.5	497
R280 271 _ _ _	18 x 60	60	3.8	533
R282 271 _ _ _	18 x 72	73	4.5	569
R248 276 _ _ _	24 x 48	85	4.1	525
R240 276 _ _ _	24 x 60	101	4.9	561
R242 276 _ _ _	24 x 72	114	5.8	597
R208 276 _ _ _	30 x 48	101	4.5	555
R200 276 _ _ _	30 x 60	120	6.0	591
R202 276 _ _ _	30 x 72	137	7.1	628

84" AND 96" TOPS HAVE A CENTER SUPPORT LEG.

TASSK TABLES (cont.)

EXAMPLE: R300 386 ___

2 digits indicate
paint finish:
77 Black
85 Med. Grey
21 Nickel
98 Pewter
45 Taupe

letter indicates
T mold shape:
S Standard
B Bullnose
F Fluted

Trapezoid Top — Cantilever Legs

Fixed leg with insert / fixed modesty panel

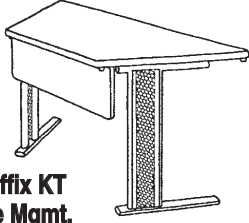

Add Suffix **KT**
for Wire Mgmt.

ITEM NUMBER	TOP SIZE	TOTAL WEIGHT	CUBIC FEET	PRICE
R324 376 ___	24 x 48	76	5.3	695
R336 376 ___	30 x 60	99	6.6	722
	KT Factory installed grommets (one left, one right)			112
	KS Factory installed single center grommet			75

Fixed leg without insert / fixed modesty panel

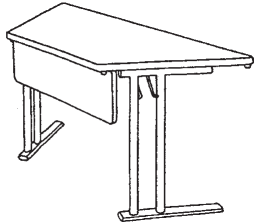

R324 276 ___	24 x 48	74	5.3	618
R336 276 ___	30 x 60	97	6.6	649

Fixed leg with insert / no modesty panel

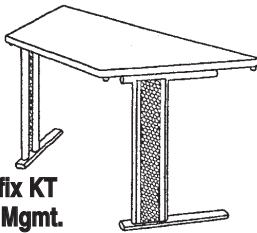

Add Suffix **KT**
for Wire Mgmt.

R224 376 ___	24 x 48	63	4.0	638
R236 376 ___	30 x 60	86	5.0	669
	KT Factory installed grommets (one left, one right)			112
	KS Factory installed single center grommet			75

Fixed leg without insert / no modesty panel

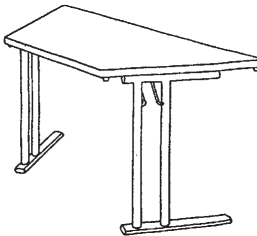

R224 276 ___	24 x 48	61	4.0	566
R236 276 ___	30 x 60	84	5.0	593

Wedge Tops

ILLUSTRATION	ITEM NUMBER	TOP SIZE	TOTAL WEIGHT	CUBIC FEET	PRICE	STANDARD SPECIFICATIONS
	MW94 475 ___	24" X 90°	18	2	301	<ul style="list-style-type: none"> • 2 Attachment brackets • 1 1-1/2" Single column post leg • NOT a free standing unit
	MW90 475 ___	30" X 90°	30	2.7	338	

Half Round Top — Cantilever Legs

Fixed leg with insert / no modesty panel

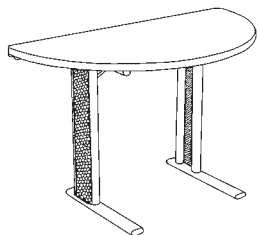

ITEM NUMBER	TOP SIZE	TOTAL WEIGHT	CUBIC FEET	PRICE
R258 376 ___	24 x 48	72	4.2	638
R250 376 ___	30 x 60	98	6.0	711

Fixed leg without insert / no modesty panel

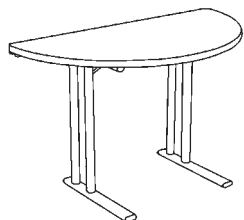

R258 276 ___	24 x 48	70	4.2	566
R250 276 ___	30 x 60	96	6.0	638

Quarter Circle Top — Cantilever Legs

Fixed leg with insert

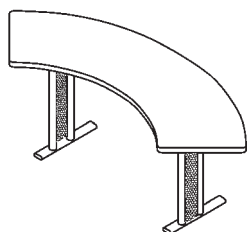

ITEM NUMBER	TOTAL WEIGHT	CUBIC FEET	PRICE	
R28Q 371 ___	18" width, quarter circle top	55	8.5	611
R24Q 376 ___	24" width, quarter circle top	63	8.5	632
R20Q 376 ___	30" width, quarter circle top	69	7.8	653

Fixed leg without insert

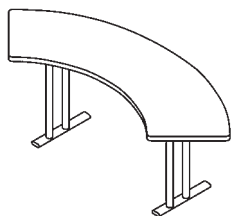

R28Q 271 ___	18" width, quarter circle top	53	8.5	539
R24Q 276 ___	24" width, quarter circle top	61	8.5	560
R20Q 276 ___	30" width, quarter circle top	67	7.8	581

Rectangular Top — T Legs

Folding legs with insert / no modesty panel

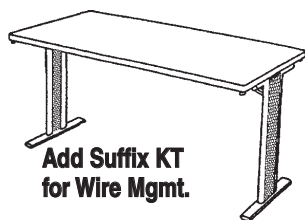

**Add Suffix KT
for Wire Mgmt.**

N/A	24 x 48	—	—	—
R240 326 ___	24 x 60	103	4.9	688
R242 326 ___	24 x 72	116	5.8	719
N/A	30 x 48	—	—	—
R200 326 ___	30 x 60	122	6.0	717
R202 326 ___	30 x 72	139	7.1	750
KT	Factory installed grommets (one left, one right)			112
KS	Factory installed single center grommet			75

Folding legs without insert / no modesty panel

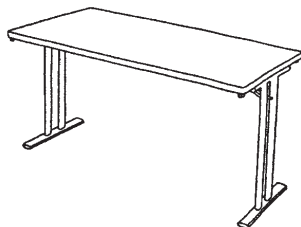

N/A	24 x 48	—	—	—
R240 226 ___	24 x 60	101	4.9	612
R242 226 ___	24 x 72	114	5.8	645
N/A	30 x 48	—	—	—
R200 226 ___	30 x 60	120	6.0	643
R202 226 ___	30 x 72	137	7.1	675

TASSK TABLES (cont.)

EXAMPLE: R300 386

2 digits indicate
paint finish:
77 Black
85 Med. Grey
21 Nickel
98 Pewter
45 Taupe

letter indicates
T mold shape:
S Standard
B Bullnose
F Fluted

Fixed legs with insert / no modesty panel

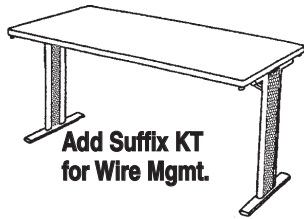

R248 316 ___	24 x 48	87	4.1	599
R240 316 ___	24 x 60	103	4.9	636
R242 316 ___	24 x 72	116	5.8	673
R208 316 ___	30 x 48	103	4.5	629
R200 316 ___	30 x 60	122	6.0	667
R202 316 ___	30 x 72	139	7.1	701
KT	Factory installed grommets (one left, one right)			112
KS	Factory installed single center grommet			75

Fixed legs without insert / no modesty panel

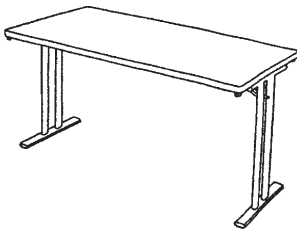

R248 216 ___	24 x 48	85	4.1	525
R240 216 ___	24 x 60	101	4.9	561
R242 216 ___	24 x 72	114	5.8	597
R208 216 ___	30 x 48	101	4.5	555
R200 216 ___	30 x 60	120	6.0	591
R202 216 ___	30 x 72	137	7.1	628

Trapezoid Top — T Legs

Fixed leg with insert / no modesty panel

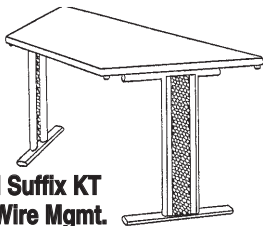

ITEM NUMBER	TOP SIZE	TOTAL WEIGHT	CUBIC FEET	PRICE
R224 316 ___	24 x 48	63	4.0	638
R236 316 ___	30 x 60	86	5.0	669
KT	Factory installed grommets (one left, one right)			112
KS	Factory installed single center grommet			75

Fixed legs without insert / no modesty panel

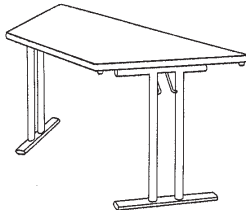

R224 216 ___	24 x 48	61	4.0	566
R236 216 ___	30 x 60	84	5.0	593

Half Round Top — T Legs

Fixed leg with insert / no modesty panel

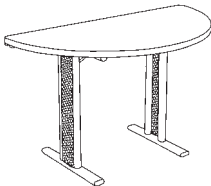

ITEM NUMBER	TOP SIZE	TOTAL WEIGHT	CUBIC FEET	PRICE
R258 316 ___	24 x 48	72	4.2	638
R250 316 ___	30 x 60	98	6.0	711

Fixed leg without insert / no modesty panel

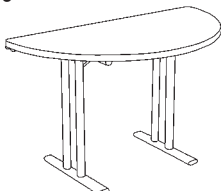

R258 216 ___	24 x 48	70	4.2	561
R250 216 ___	30 x 60	96	6.0	635



TASSK TABLES with CASTERS

Rectangular Top — Folding Cantilever Legs

Folding legs with insert / folding modesty panel

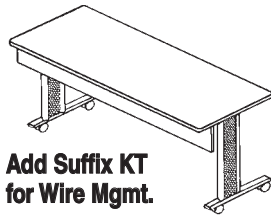

Add Suffix **KT**
for Wire Mgmt.

ITEM NUMBER	TOP SIZE	TOTAL WEIGHT	CUBIC FEET	PRICE
R340 38C _ _ _	24 X 60	119	6.3	926
R342 38C _ _ _	24 X 72	138	7.6	984
R300 38C _ _ _	30 X 60	140	7.8	956
R302 38C _ _ _	30 X 72	162	7.3	1014
KT	Factory installed grommets (one left, one right)			112
KS	Factory installed single center grommet			75

Folding legs without insert / folding modesty panel

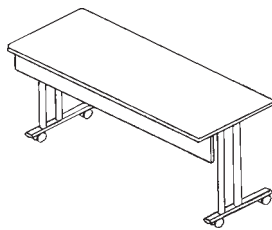

R340 28C _ _ _	24 X 60	117	6.3	849
R342 28C _ _ _	24 X 72	136	7.6	911
R300 28C _ _ _	30 X 60	137	7.8	879
R302 28C _ _ _	30 X 72	160	9.2	940

Folding legs with insert / no modesty panel

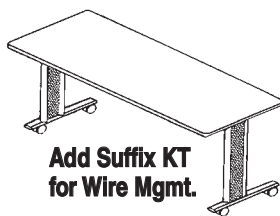

Add Suffix **KT**
for Wire Mgmt.

R240 38C _ _ _	24 X 60	103	4.9	721
R242 38C _ _ _	24 X 72	116	5.8	754
R200 38C _ _ _	30 X 60	122	6.0	752
R202 38C _ _ _	30 X 72	139	7.1	783
KT	Factory installed grommets (one left, one right)			112
KS	Factory installed single center grommet			75

Folding legs without insert / no modesty panel

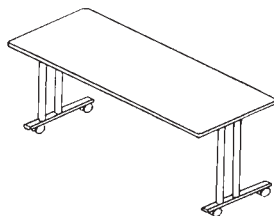

R240 28C _ _ _	24 X 60	101	4.9	647
R242 28C _ _ _	24 X 72	114	5.8	679
R200 28C _ _ _	30 X 60	120	6.0	677
R202 28C _ _ _	30 X 72	137	7.1	708



TASSK TABLES with CASTERS (cont.)

EXAMPLE: R300 386

2 digits indicate
paint finish:

77 Black
85 Med. Grey
21 Nickel
98 Pewter
45 Taupe

letter indicates
T mold shape:

S Standard
B Bullnose
F Fluted

Rectangular Top — Fixed Cantilever Legs

Fixed legs with insert / fixed modesty panel

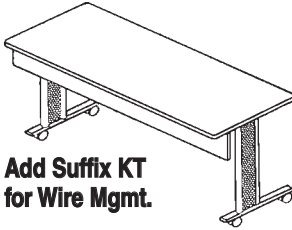

Add Suffix **KT**
for Wire Mgmt.

ITEM NUMBER	TOP SIZE	TOTAL WEIGHT	CUBIC FEET	PRICE
R348 37C ___	24 X 48	100	5.5	727
R340 37C ___	24 X 60	119	6.3	839
R342 37C ___	24 X 72	138	7.6	889
R308 37C ___	30 X 48	116	5.9	756
R300 37C ___	30 X 60	140	7.8	869
R302 37C ___	30 X 72	162	9.2	919
KT	Factory installed grommets (one left, one right)			112
KS	Factory installed single center grommet			75

Fixed leg without insert / fixed modesty panel

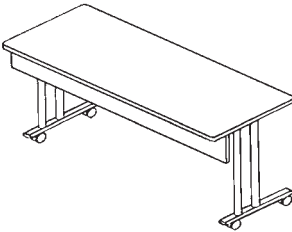

R348 27C ___	24 X 48	98	5.5	653
R340 27C ___	24 X 60	117	6.3	764
R342 27C ___	24 X 72	136	7.6	815
R308 27C ___	30 X 48	114	5.9	680
R300 27C ___	30 X 60	137	7.8	793
R302 27C ___	30 X 72	160	9.2	845

Fixed legs with insert / no modesty panel

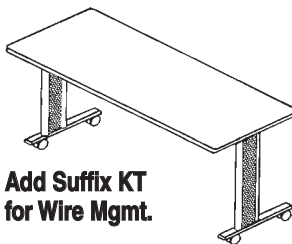

Add Suffix **KT**
for Wire Mgmt.

R248 37C ___	24 X 48	87	4.1	633
R240 37C ___	24 X 60	103	4.9	672
R242 37C ___	24 X 72	116	5.8	707
R208 37C ___	30 X 48	103	4.5	664
R200 37C ___	30 X 60	122	6.0	700
R202 37C ___	30 X 72	139	7.1	737
KT	Factory installed grommets (one left, one right)			112
KS	Factory installed single center grommet			75

Fixed leg without insert / no modesty panel

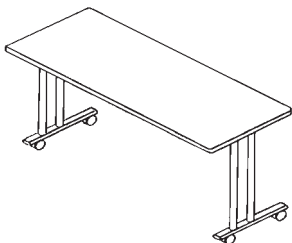

R248 27C ___	24 X 48	85	4.1	560
R240 27C ___	24 X 60	101	4.9	595
R242 27C ___	24 X 72	114	5.8	633
R208 27C ___	30 X 48	101	4.5	590
R200 27C ___	30 X 60	120	6.0	626
R202 27C ___	30 X 72	137	7.1	662

TASSK TABLES with CASTERS (cont.)

Trapezoid Top — Fixed Cantilever Legs

Fixed leg with insert / fixed modesty panel

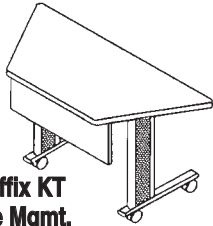

**Add Suffix KT
for Wire Mgmt.**

Fixed leg without insert / fixed modesty panel

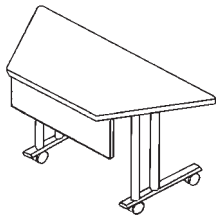

Fixed leg with insert / no modesty panel

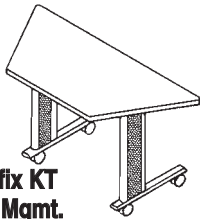

**Add Suffix KT
for Wire Mgmt.**

Fixed leg without insert / no modesty panel

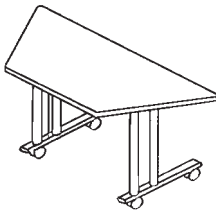

ITEM NUMBER	TOP SIZE	TOTAL WEIGHT	CUBIC FEET	PRICE
R324 37C ___	24 X 48	76	5.3	732
R336 37C ___	30 X 60	99	6.6	759
KT	Factory installed grommets (one left, one right)			112
KS	Factory installed single center grommet			75

R324 27C ___	24 X 48	74	5.3	655
R336 27C ___	30 X 60	97	6.6	685

R224 37C ___	24 X 48	63	4.0	674
R236 37C ___	30 X 60	86	5.0	702
KT	Factory installed grommets (one left, one right)			112
KS	Factory installed single center grommet			75

R224 27C ___	24 X 48	61	4.0	599
R236 27C ___	30 X 60	84	5.0	629

Half Round Top — Fixed Cantilever Legs

Fixed leg with insert / no modesty panel

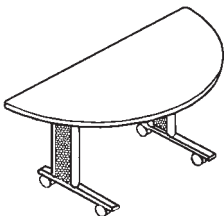

R258 37C ___	24 X 48	72	4.2	674
R250 37C ___	30 X 60	98	6.0	746

Fixed leg without insert / no modesty panel

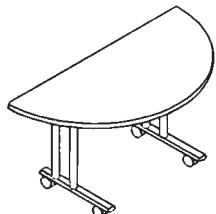

R258 27C ___	24 X 48	72	4.2	599
R250 27C ___	30 X 60	98	6.0	629



TASSK TABLES

ADA HEIGHT LEGS

Tops and Legs Numbered Separately — Must Order Both

Fixed modesty panel

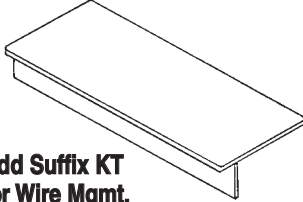

**Add Suffix KT
for Wire Mgmt.**

No modesty panel

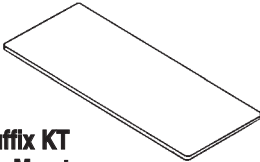

**Add Suffix KT
for Wire Mgmt.**

Fixed modesty panel

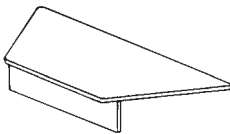

Add Suffix KT for Wire Mgmt.

No modesty panel



Add Suffix KT for Wire Mgmt.

No modesty panel

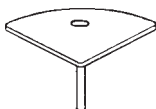
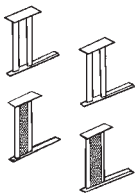

ITEM NUMBER	TOP SIZE	TOTAL WEIGHT	CUBIC FEET	PRICE
Rectangular Top				
R348K7	24 X 48	73	5.5	500
R340K7	24 X 60	92	6.3	536
R342K7	24 X 72	111	7.6	572
R308K7	30 X 48	89	5.9	518
R300K7	30 X 60	112	7.8	551
R302K7	30 X 72	135	9.3	589
KT	Factory installed grommets (one left, one right)			112
KS	Factory installed single center grommet			75

Rectangular Top				
R248K7	24 X 48	75	4.1	381
R240K7	24 X 60	91	4.9	398
R242K7	24 X 72	104	5.8	416
R208K7	30 X 48	91	4.5	398
R200K7	30 X 60	110	6.0	416
R202K7	30 X 72	127	7.1	432
KT	Factory installed grommets (one left, one right)			112
KS	Factory installed single center grommet			75

Trapezoid Top				
R324K7	24 X 48	49	5.3	394
R336K7	30 X 60	74	6.6	481
KT	Factory installed grommets (one left, one right)			112
KS	Factory installed single center grommet			75
R224K7	24 X 48	51	4.0	311
R236K7	30 X 60	74	5.0	398
KT	Factory installed grommets (one left, one right)			112
KS	Factory installed single center grommet			75

Half Round Top				
R258K7	24 X 48	62	4.1	381
R250K7	30 X 60	88	6.0	416

Cantilever Fixed Legs Only				
27T 77	black without leg inserts Leg height 3/2 5/8"			203
37T 77	black with leg inserts			251

Wedge Tops (With Round Leg)				
MW94 47T 77	black	90° X 24		321
MW90 47T 77	black	90° X 30		356



TASSK TABLES FLIP TOPS

Tops and Legs Numbered Separately — **Must Order Both**

Fixed modesty panel

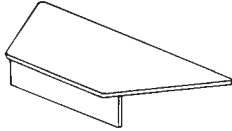

Add Suffix KT for Wire Mgmt.

No modesty panel



Add Suffix KT for Wire Mgmt.

No modesty panel

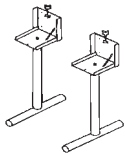
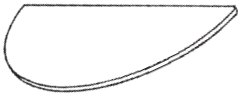



ITEM NUMBER	TOP SIZE	TOTAL WEIGHT	CUBIC FEET	PRICE
Trapezoid Top				
R324K7	24 X 48	49	5.3	394
R336K7	30 X 60	74	6.6	481
KT	Factory installed grommets (one left, one right)			112
KS	Factory installed single center grommet			75
Half Round Top				
R224K7	24 X 48	51	4.0	311
R236K7	30 X 60	74	5.0	398
KT	Factory installed grommets (one left, one right)			112
KS	Factory installed single center grommet			75
Flip Top Mechanism Legs				
101 77	Flip-top legs			609

2 digits indicate paint finish:
 77 Black
 85 Med. Grey
 21 Nickel
 98 Pewter
 45 Taupe

Tassk Tables / Conference Table Accessories Lecterns

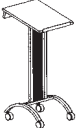
• New Stand Up lecterns for Training and Conference areas. • Lecterns coincide with our current Tassk table versions, Arch leg and Cantilever. • Assists the end-user by offering a more complete training application or conference package. • Table top lectern can be used with Conference tables or Tassk tables and is small enough to be stored easily when not in use. • Available in our standard paints and 24 standard laminates

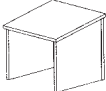
ITEM NUMBER	FINISH	DESCRIPTION	MORE	APX WT	PRICE
			DESCRIPTION	PACK/CUBE	
	paint	stand-up lectern arch foot, casters Chromcraft standard laminates	W 20.25	34	503
			D 20.25	1 PK, SU	
			H 47	14.7 cu	
	paint	stand-up lectern flat foot, casters Chromcraft standard laminates	W 20.25	34	471
			D 20.25	1 PK, SU	
			H 47	14.7 cu	
	Laminate	tabletop lectern Chromcraft standard laminates	W 19	28	335
			D 18.25	1 PK, SU	
			H 17.75	5 cu	

Tassk Table Cart and Electrical



ITEM NUMBER	SIZE W.D.H.	TOTAL WEIGHT	CUBIC FEET	PRICE
A201-77	30 x 73 x 41	100	7.6	1274

Cart available in Black, ONLY. 6" casters. – Carries 5 tables.

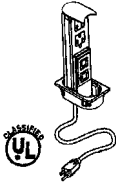
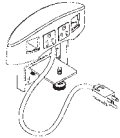

ITEM NUMBER	DESCRIPTION	TOTAL WEIGHT	CUBIC FEET	PRICE	STANDARD SPECIFICATIONS
A006	Power/Data Center — (attaches to edge of table)	1	—	290	Standard Features: <ul style="list-style-type: none"> • 2 Simplexes • 6 Ft., 15 Amp cord • Adjustable rear clamp attaches to a variety of work surface thicknesses (a minimum of 1" clearance between work surface and panel wall required) • 2 Voice/Data ports
A007	Retractable Power/Data Center (installs into wire management grommet) (grommet not included)	1	—	208	Standard Features: <ul style="list-style-type: none"> • Retractable • 2 Simplexes • 6 Ft., 15 Amp cord • Fits into our wire management grommet • 2 Voice/Data ports

DAISY LINK WIRING FOR TASSK TABLES

Links must be connected in sequence (Maximum Eight). Will NOT connect out of sequence.

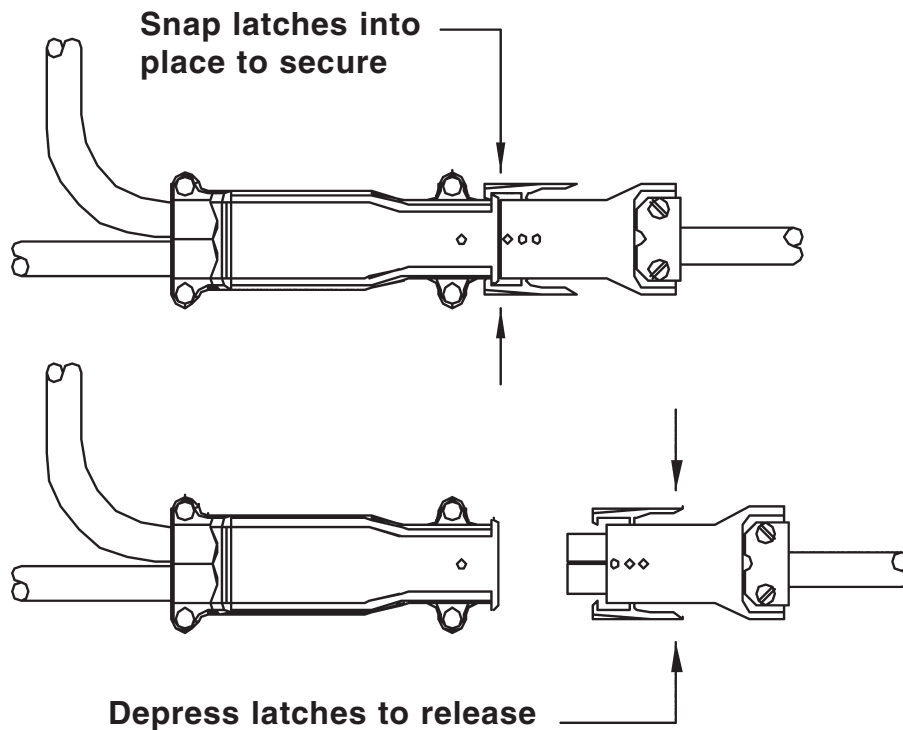
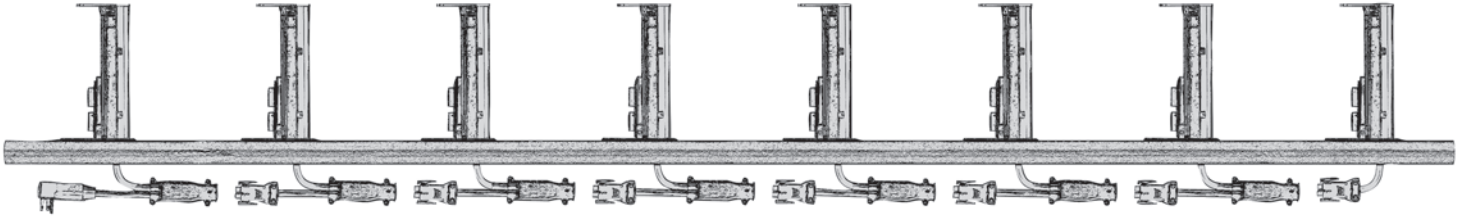

Maximum number of links is eight. Each link includes pop up receptacle.

Chromcraft item # (LINK #)	link color codes	connects to	power cord length	List Price
ALK1-BK	Black	Power Source	120"	314
ALK2-BK/RD	Black/Red	ALK1	60"	221
ALK3-RD/BL	Red/Blue	ALK2	60"	221
ALK4-BL/OR	Blue/Orange	ALK3	60"	221
ALK5-OR/YL	Orange/Yellow	ALK4	60"	221
ALK6-YL/GN	Yellow/Green	ALK5	60"	221
ALK7-GN/WH	Green/White	ALK6	60"	221
ALK8-WH	White	ALK7	60"	221

CHROMCRAFT  CONTRACT

A Chromcraft Revington Company

P.O. Box 126 • Senatobia, MS 38668 USA
Dealer Service 1-866-777-1951 • Fax 800-336-1651
www.chromcraftcontract.com